

DLP-PRESSRITE, INC.

*High Quality Exterior and Interior
Door Components and Hardware*

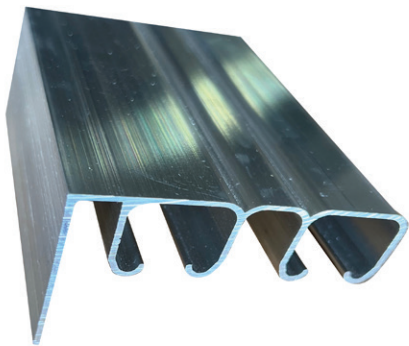
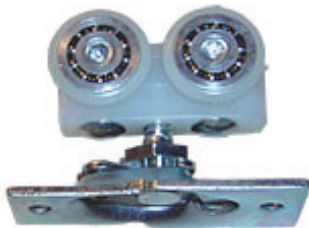

Bi-Fold Door Detail Under Header Installation

Who We Are

Consistent Quality Without Compromise

Our Mission

To provide the most reliable interior and exterior hardware for your door systems and the best possible customer service experience possible.

Our Story

Since 1974, DLP-PRESSRITE, INC. has been manufacturing quality closet door and shutter hardware. Prior to 1984, all our products were sold exclusively under the label Crawford Manufacturing. In 1984, DLP-PRESSRITE acquired Crawford Manufacturing and continued to manufacture the same quality hardware under its own label. In 1989, we began manufacturing thresholds and developing new technologies for exterior door components and we never stopped. Today we have a full line of hardware components for interior and exterior doors and are continuing to develop to meet the changing needs of our customers. Located in Florida, we have enjoyed great relationships in our state and although our concentration has been on supplying customers in the Southeastern states, our product quality and prompt service have earned us many loyal customers nationwide.

Our Philosophy

As a family owned and operated, free market, door component company DLP-PRESSRITE stands out among hardware suppliers because of who we are and what we stand for:

- We make hardware that stands the test of time.
- We do what we say we will do and do it right the first time, so we ship your orders to spec and on time to help your business succeed.
- We strive to be fair and honest with all our customers and vendors.
- We are committed to helping your business and satisfying your customers and our customer service is second to none from stock orders to job site installations.

What To Expect From Us

DLP-PRESSRITE represents American manufacturing at its best. With a workforce of skilled craftsmen and tradesmen, our South Florida plant produces quality door components and door hardware that lasts. This means better quality, fewer delays, and shorter lead times for our customers. Most importantly, at DLP-PRESSRITE, customer service is our top priority. We will help you and your business at every level of your sales structure. We help with custom specs, marketing our products to your customers, and handling end-user issues from complaints to installations. We stand out because we believe in our products, and we stand up for our customers.



DLP Door Components, Windsert Venting Lights, and Pressrite Track & Hardware.
High Quality Interior and Exterior Door Components and Hardware Since 1974.

DLP-PRESSRITE, INC.

Product Offering



DLP DOOR COMPONENTS

Astragals.....	4-5
Inswing Thresholds.....	6-7
Outswing Thresholds.....	8-9
ADA Thresholds.....	10-11
Replacement Thresholds, Sweeps, and Accessories.....	12-13
Windsert.....	14-15

PRESSRITE TRACK AND HARDWARE

Pocket Door Heavy Duty	16-17
Bi-Fold Door Standard Duty.....	18-19
Bi-Fold Door Heavy Duty.....	20-21
Bypass Door Standard Duty.....	22-23
Bypass Door Split Header.....	24-25
Bypass Door Heavy Duty.....	26-27
Hardware Kits	28-30
All Hardware	31-32

Commitment To Quality

Being made in America has certain advantages. All our hardware is made to order and to spec. We will match your notches, bore locations, multipoint hardware, and lock and deadbolt locations so that you don't have to adjust anything either in the door shop or on the job site. Our products are designed to take the headache out of installation and assembly.

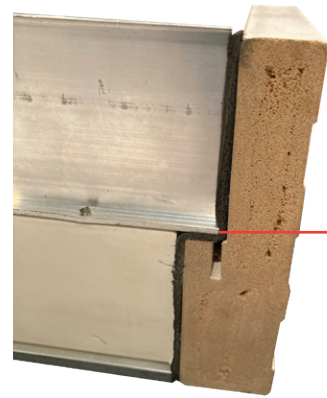

PREP TO ORDER
FLUSH CUT
L-NOTCH
C-NOTCH

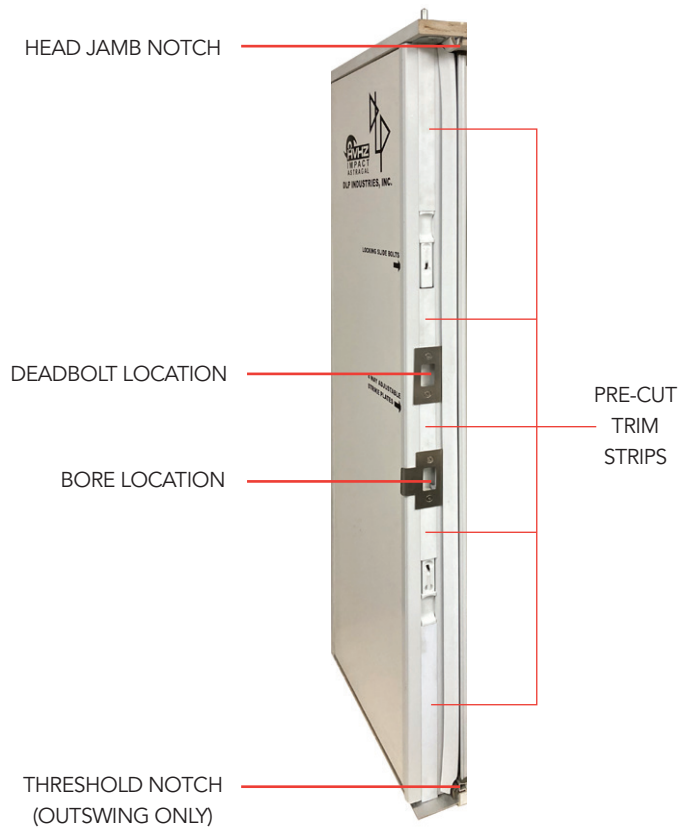

Commitment To Innovation

At DLP-PRESSRITE, we are committed to providing products for our customers not just finding customers for our products. This means new extrusions, new technologies, and most recently, new styles. Our most recent innovations have been our Flat Profile Astragal and our Black Finish for Astragals and Thresholds.

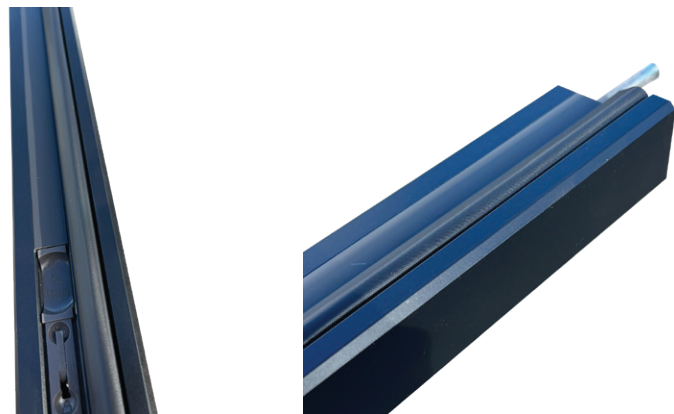
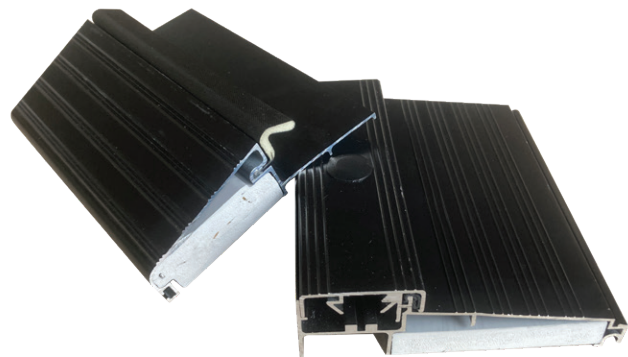
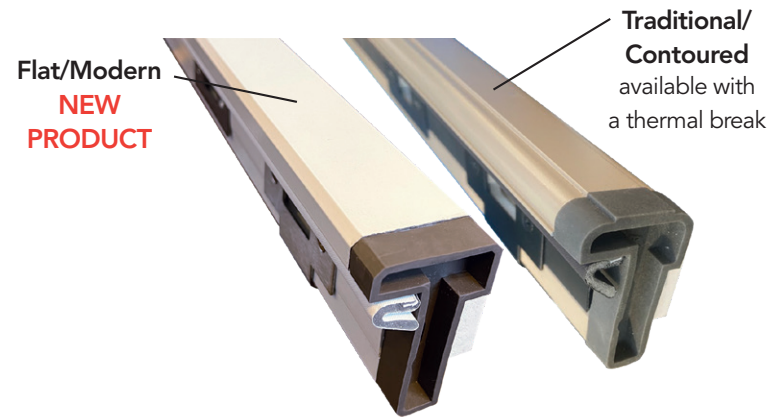

Hurricane Code Compliance

Providing stronger door components since 1999, DLP is the industry leader for securing your door systems against the environment. South Florida born and raised, DLP-Pressrite has weathered not only storms in the economy but the many hurricanes that have ravaged the Southeastern United States. DLP has provided hurricane rated aluminum thresholds and astragals for the state of Florida since 2000 and has become the industry standard regarding High Velocity Hurricane Zone door components.

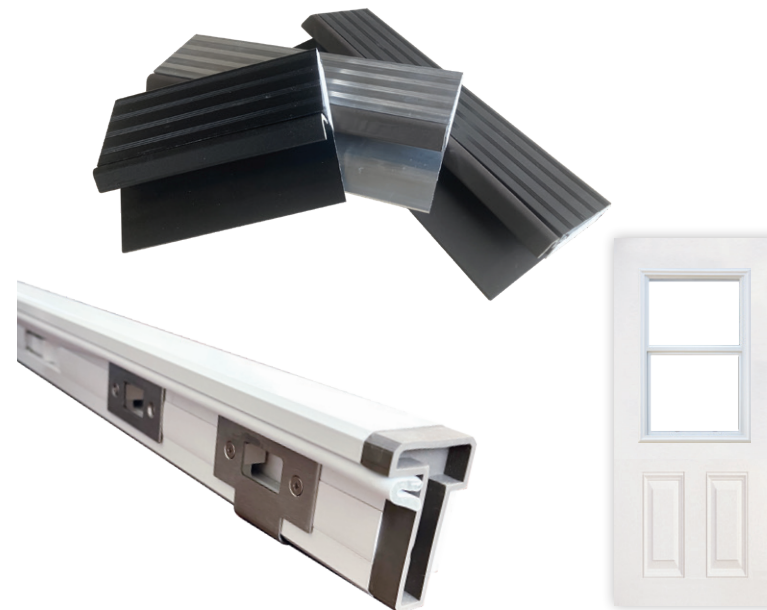

Security

The weakest parts of any home are typically the doors and windows. DLP's impact rated Windsert and fully aluminum t-astragal are designed to strengthen your home.



Secure flip lever locks

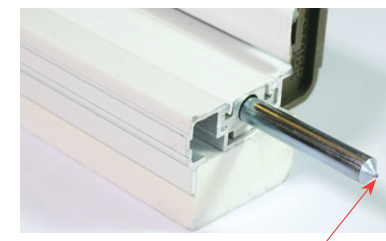

Slide bolt w/machined center punch allows for precise bolt location and ease of installation.

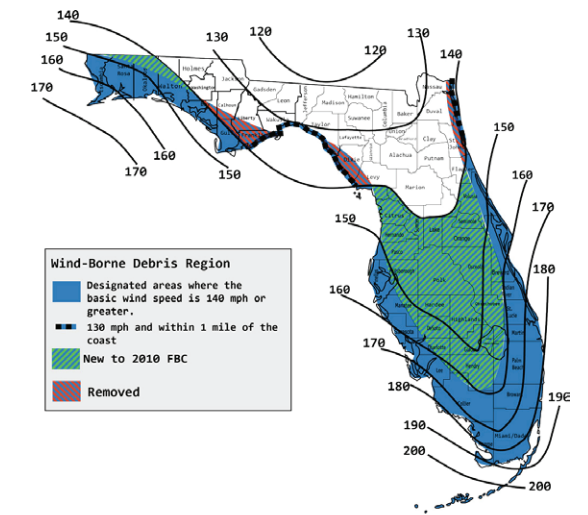
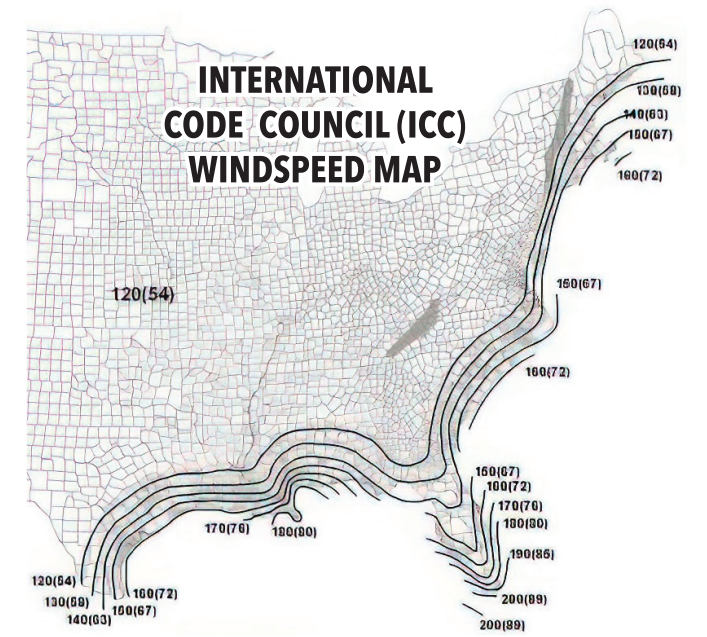
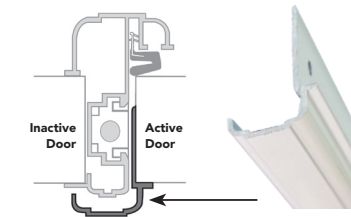
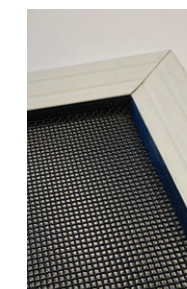

Figure 1609B Risk Category IV Buildings and Structures and Category III healthcare facilities



Add on an Astragal Security Strip to any **outswing** double door combination for added security and a clean finished appearance eliminating the reveal between the doors.



OPTIONAL SECURITY SCREEN

- High Tensile 304 Stainless Security mesh
 - Tight pattern for insect control
 - Rigid structure for impact deflection (passes hurricane impact test with window open)
- Windsert security screen is available for all door sizes

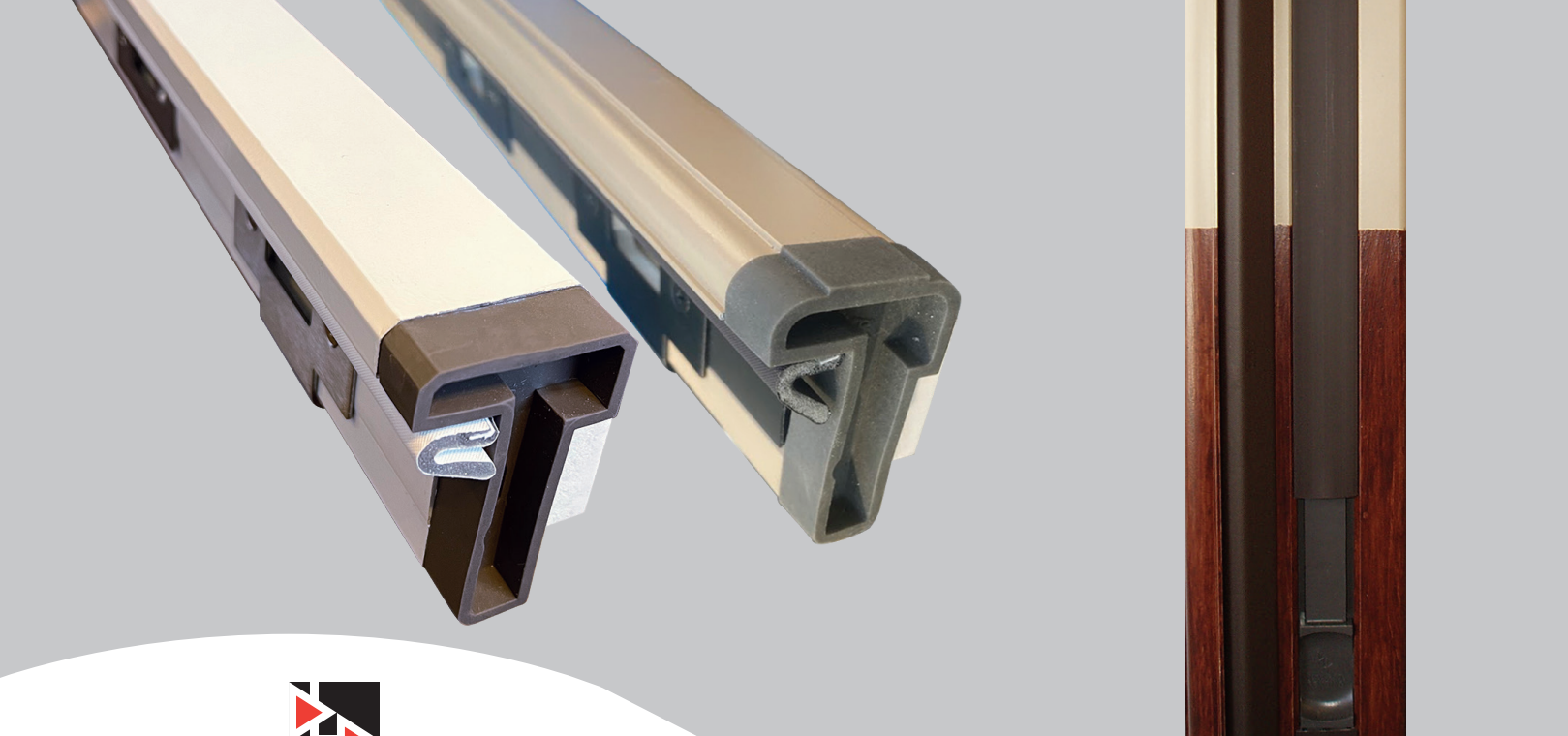

DLP DOOR COMPONENTS

Aluminum T-Astragals For 1-3/4" Exterior Doors

DLP's astragals exhibit superior structural design and meet the strict Florida building code requirements for the High Velocity Hurricane Zone. The DLP astragal is tailored to provide your double door entryway with increased security and weather protection. Engineered for easy installation and operation, they have multiple advanced features:

- 4-way adjustable strike plates for perfect alignment of door hardware
- Designed for simple installation
 - Fitted with #8 self-drilling pan head screws
 - No bolt casing disassembly required
- Advanced slide bolt with:
 - Patented locking flip lever for security
 - Machined center punch for a precise bolt location and ease of installation
- Finish Options
 - White
 - Black
 - Bronze
 - Stainable coating designed for top coating to match your door finish, that accepts oil, gel, or water-based stains and oil, latex, or water-based paints.
- Come standard with Q-Ion weatherstripping and unique rubber boot seals
- Prepped to any specifications for door height, bore and deadbolt locations, and head jamb and sill notches for no additional fee
- Prepped to multi-point hardware specifications for a fee
- Component approval FL14805.4 - FL14805.7

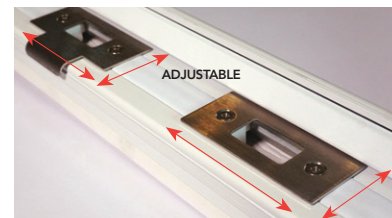

4-way adjustable (horizontal and vertical) strike latch plates



Secure flip lever locks

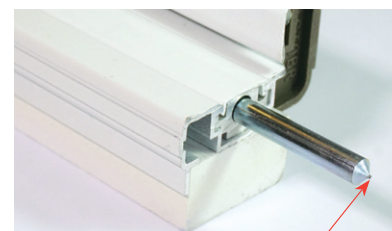

Slide bolt w/machined center punch allows for precise bolt location and ease of installation.

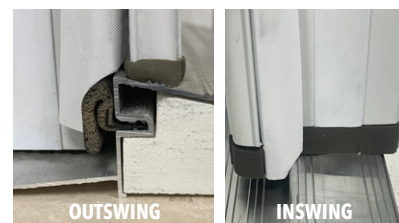

Astragals come standard with Q-Ion weatherstripping and rubber boot seals.

ALUMINUM T-ASTRAGAL

DOOR HEIGHT	DESCRIPTION	BOX QTY
6/8, 8/0		
Nominal Lengths: 6/8 79-1/4"	Left Hand Inswing	6
8/0 95-1/4"	Right Hand Inswing	6
Custom Options: • Cut Down Lengths • Multipoint Prep • Special Strike Locations • Specific Notching	Left Hand Outswing	6
	Right Hand Outswing	6

SPECIFICATIONS

Sizing determined by:

- Door Height
- Lock/Strike Preps
 - Locations
 - Single or Multipoint
- Notch Depth Cut for Threshold (Outswing only; see the drawings above)

FINISH

White, Black, Bronze and Stainable

- White Astragals come standard with white weatherstripping and stainless steel strike plates
- Black, Bronze and Stainable Astragals come standard with bronze weatherstripping and bronze strike plates

ASTRAGAL SECURITY STRIPS

ITEM#	DESCRIPTION	FINISH
6/8, 8/0		
ASTSS Nominal Lengths: 6/8 79-1/4" 8/0 95-1/4"	Left Hand Outswing Door	White Stainable
	Right Hand Outswing Door	White Stainable

Special sizing available.

Astragal Security Strips are the same hand as the active door.



Outswing astragals have threshold and head notch / inswing astragals have only head notch. Standard size notches listed above, other notch sizes can be made.

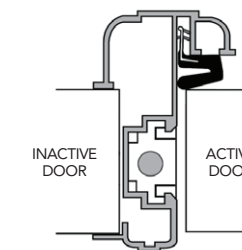
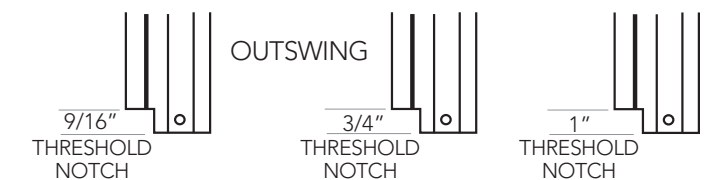

Astragal handing is ordered **OPPOSITE** of the active door.

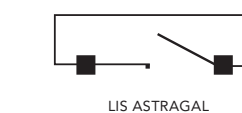

LIS ASTRAGAL



ROS ASTRAGAL



LOS ASTRAGAL



RIS ASTRAGAL

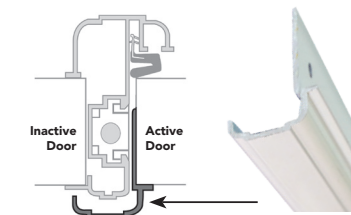

Add on an Astragal Security Strip to any **outswing** double door combination for added security and a clean finished appearance eliminating the reveal between the doors.



DLP DOOR COMPONENTS

INSWING Thresholds and Accessories

Making durable thresholds since 1987, DLP's threshold designs are built to last. Keeping the bugs and water out and the air in, DLP thresholds have been tested with several door systems to pass the stringent Florida building codes.

- DLP offers a full line of inswing, outswing, and ADA compliant aluminum thresholds
- Available in a variety of profiles
- Black, bronze and mill finish
- Manufactured in the USA



ADJUSTABLE SCREWS
(WEATHER SEAL IS HIDDEN FOR ISCS)

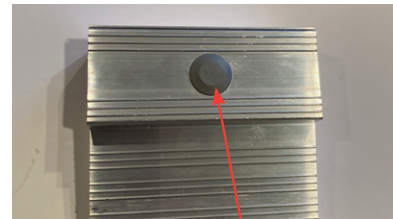

SCREW HOLE CAP



OPTIONAL JAMB
AND THRESHOLD SEALS

MODEL	SPECIFICATIONS	DIAGRAM
ISCS	Inswing Covered Seal adjustable threshold for use with 4 9/16" jambs This threshold adjusts from 1 1/4" up to 1 1/2" high Options: Mill, Bronze, or Black Finish Sill extender EXT1 for 5 1/4" jambs Sill extender EXT3 for 6 9/16" jambs	
ISW	Inswing Height Adjustable Wide threshold for 5 1/4" jambs This threshold adjusts from 1 1/8" up to 1 5/16" high Options: Mill or Bronze Finish Sill extender EXT2 for 6 9/16" jambs Sill extender EXT3 for 7 1/4" jambs	
ISH series	Inswing Height Adjustable threshold for 4 9/16" jambs This threshold adjusts from 1 1/8" up to 1 5/16" high Options: Mill or Bronze Finish	

Threshold profiles are not to a consistent scale, identify individually using dimensions

MODEL	SPECIFICATIONS	DIAGRAM
ISO series	Inswing Oak adjustable height threshold for 4 9/16" jambs This threshold features a beautiful natural red oak riser and adjust from 1 1/4" to 1 1/2" high Options: Mill or Bronze Finish	
ISWO series	Inswing Oak adjustable height threshold for 5 1/4" jambs This threshold features a beautiful natural red oak riser and adjust from 1 1/4" to 1 1/2" high Options: Mill or Bronze Finish Sill extender EXT2 for 6 9/16" jambs Sill extender EXT3 for 7 1/4" jambs	
DBFIS series	Fixed Inswing threshold with screw veins for use with 4 9/16" jambs Options: Mill Finish Sill extender DBFISEXT1 for 5 1/4" jambs Sill extender DBFISEXT2 for 6 9/16" jambs	
LS series	11/16" high Inswing "Low Saddle" threshold with screw holes Options: Mill Finish Individually Packed in poly tubing	
HS series	15/16" high Inswing "High Saddle" threshold with screw holes Options: Mill or Bronze Finish Individually Packed in poly tubing	
EXT1	Extender for ISCS for 5 1/4" jambs Options: Black, Bronze, Mill	
EXT2	Extender for ISW, ISWH, ISWO for 6 9/16" jambs Options: Bronze, Mill	
EXT3	Extender for ISCS for 6 9/16" jambs, Extender for ISW, ISWH, ISWO for 7 1/4" jambs Options: Black, Bronze, Mill	
DBFIS EXT1	Extender for DBFIS for 5 1/4" jambs Options: Mill Finish	
DBFIS EXT2	Extender for DBFIS for 6 9/16" jambs Options: Mill Finish	

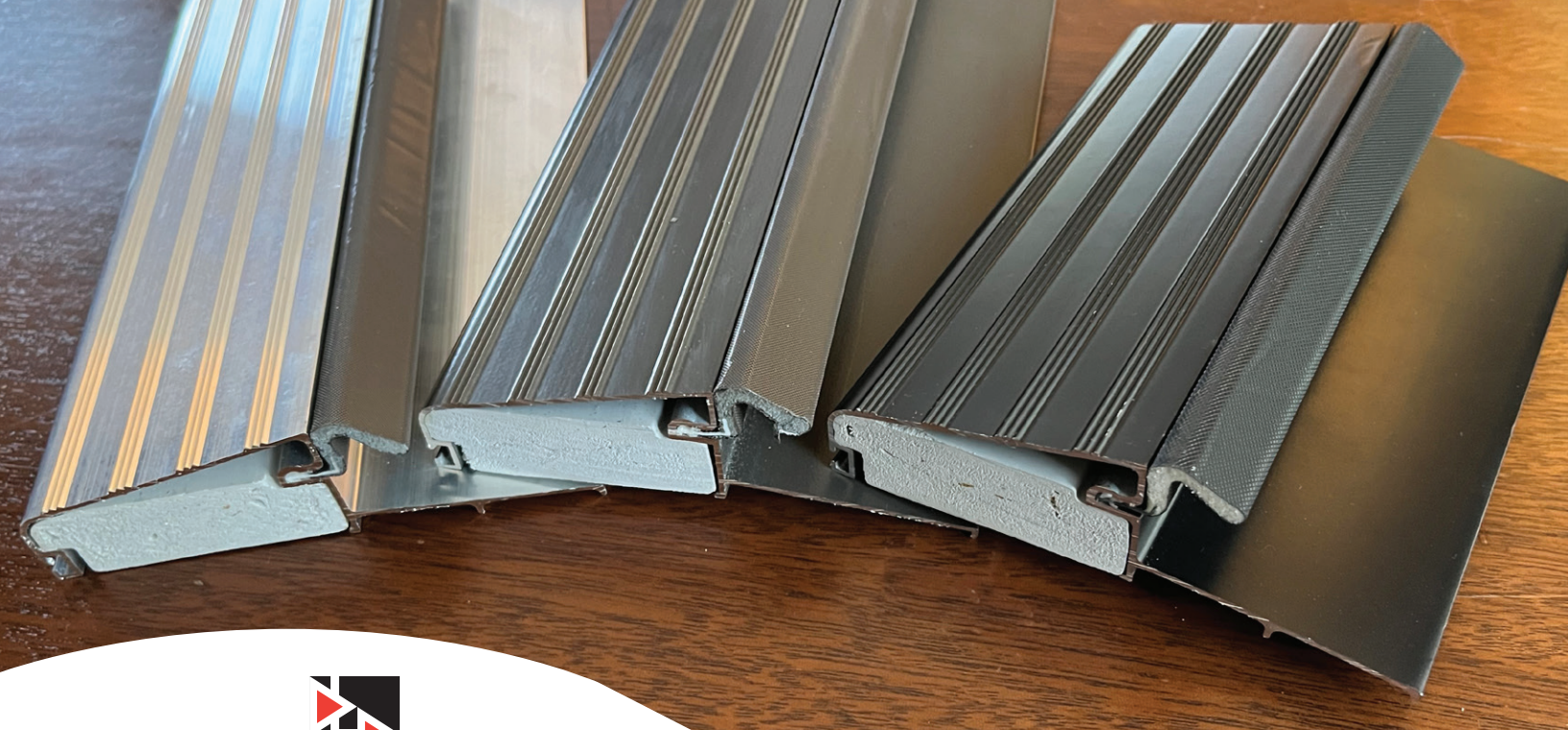

DLP DOOR COMPONENTS

OUTSWING Thresholds and Accessories

Making durable thresholds since 1987, DLP's threshold designs are built to last. Keeping the bugs and water out and the air in, DLP thresholds have been tested with several door systems to pass the stringent Florida building codes.

- DLP offers a full line of inswing, outswing, and ADA compliant aluminum thresholds
- Available in a variety of profiles
- Black, bronze and mill finish
- Manufactured in the USA
- All substrates are composite

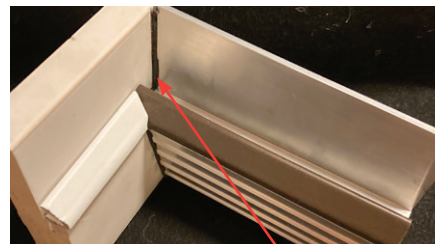

OPTIONAL JAMB SEALS



Q-LON WEATHERSTRIPPING



REVERSE HIGH DAM PREVENTS WATER INFILTRATION

OUTSWING THRESHOLDS & ACCESSORIES

MODEL	SPECIFICATIONS	DIAGRAM	MODEL	SPECIFICATIONS	DIAGRAM
QOS Series	1" high QLON Outswing threshold for use with 4 9/16" jambs Options: Mill Finish Jamb notches Screw holes		LB series	5/8" high "Low Bumper" Outswing bump threshold with screw holes Options: Mill Finish Individually Packed in poly tubing	
QOSR	1 1/4" high Outswing threshold for use with 4 9/16" jambs <i>This threshold eliminates HVHZ water infiltration issues and works well with marble flooring</i> Options: Mill, Bronze, or Black Finish Jamb notches Screw holes		HB series	1" high "High Bumper" Outswing bump threshold with screw holes Options: Mill or Bronze finish Individually Packed in poly tubing	
QOSO Series	1 3/8" high QLON Outswing Oak threshold for use with 4 9/16" jambs <i>This threshold features a beautiful natural red oak top</i> Options: Mill or Bronze Finish Jamb notches		EXT1 QOSH EXTENDER	EXT1 extends the QOSH to 5-1/4" width Options: Black, Bronze, Mill	
QOS05 Series	1 1/4" high QLON Outswing Oak threshold for use with 5 1/4" jambs <i>This threshold features a beautiful natural red oak top</i> Options: Mill or Bronze Finish Jamb notches		EXT2 QOSH EXTENDER	EXT2 extends the QOSH to 6-9/16" width Options: Black, Bronze, Mill	
QOS06 Series	1 1/4" high QLON Outswing Oak threshold for use with 6 9/16" jambs <i>This threshold features a beautiful natural red oak top</i> Options: Mill or Bronze Finish Jamb notches		EXT1 QOSR EXTENDER	EXT1 converts QOSR to 5-1/4" Width Options: Black, Bronze, Mill	
QOSH Series	1 1/4" high QLON Outswing threshold for use with 4 9/16" jambs Options: Mill, Bronze, or Black Finish Jamb notches Screw holes		EXT2 QOSR EXTENDER	EXT2 converts QOSR to 6-9/16" Width Options: Black, Bronze, Mill	
DBQOSH Series	1 1/4" high QLON Outswing threshold with screw veins for use with 4 9/16" jambs Options: Mill Finish Jamb notches Screw holes				

***UNLESS OTHERWISE NOTED, OUTSWING SILLS HAVE 2 7/16" DEPTH FLUSH NOTCH**

Threshold profiles are not to a consistent scale, identify individually using dimensions

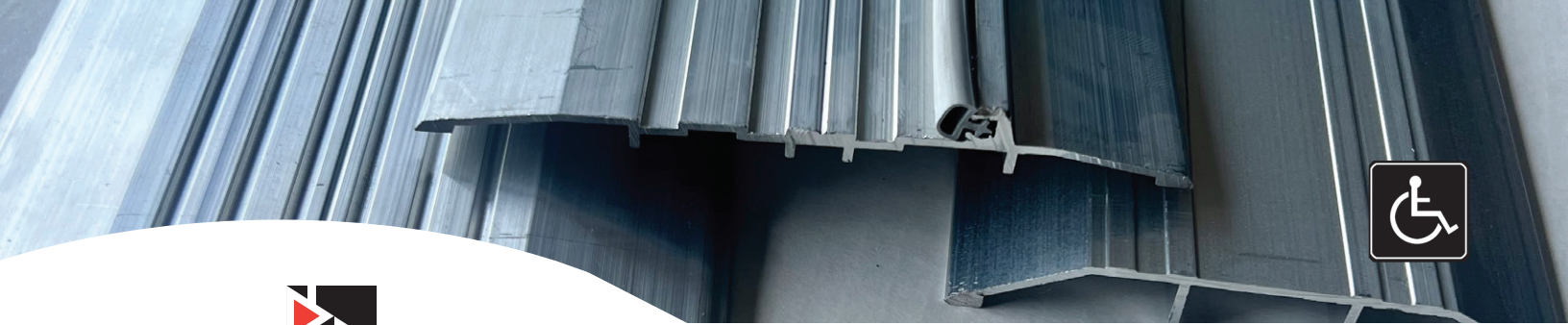

DLP DOOR COMPONENTS

ADA Thresholds and Accessories

Making durable thresholds since 1987, DLP's threshold designs are built to last. Keeping the bugs and water out and the air in, DLP thresholds have been tested with several door systems to pass the stringent Florida building codes.

- DLP offers a full line of inswing, outswing, and ADA compliant aluminum thresholds
- Available in a variety of profiles`
- Mill finish
- Manufactured in the USA

MODEL	SPECIFICATIONS	DIAGRAM
ISHC4	A.D.A. Approved 4" wide x 1/2" high Inswing handicap threshold with screw holes Options: Mill Finish Jamb Notches Countersunk screw holes	
ISHCL5	A.D.A. Approved 5" wide x 1/4" high Inswing handicap threshold with screw holes Options: Mill Finish Jamb Notches Countersunk screw holes	
ISHC	A.D.A. Approved 5" wide x 1/2" high Inswing handicap threshold with screw holes Options: Mill Finish Jamb Notches Countersunk screw holes	
ISHC6	A.D.A. Approved 6" wide x 1/2" high Inswing handicap threshold with screw holes Options: Mill Finish Jamb Notches Countersunk screw holes	

Threshold profiles are not to a consistent scale, identify individually using dimensions

ISTB	A.D.A. Approved 4" wide x 1/2" high Inswing handicap threshold with screw holes *** This threshold was designed to butt up to tile or other floor coverings Options: Mill Finish Jamb Notches Countersunk screw holes	
OSHC	A.D.A. Approved 5" wide x 1/4" high Outswing handicap threshold with vinyl weatherstrip and mounting holes Options: Mill Finish Jamb Notches Countersunk screw holes	
TCHC	A.D.A. Approved 4 1/4" wide x 1/2" high Outswing handicap threshold with vinyl weatherstrip and mounting holes Options: Mill Finish Jamb Notches Countersunk screw holes	
DB4375TB	A.D.A. Approved 4 3/8" wide x 1/2" high Inswing tile back handicap threshold Options: Mill Finish Jamb Notches Countersunk screw holes	
DB5375TB	A.D.A. Approved 5 3/8" wide x 1/2" high Inswing tile back handicap threshold Options: Mill Finish Jamb Notches Countersunk screw holes	
DB6375TB	A.D.A. Approved 6 3/8" wide x 1/2" high Inswing tile back handicap threshold Options: Mill Finish Jamb Notches Screw Holes	
DB456SDL	A.D.A. Approved 4 9/16" wide x 1/2" high Inswing saddle handicap threshold Options: Mill Finish Jamb Notches Screw Holes	
DB556SDL	A.D.A. Approved 5 9/16" wide x 1/2" high Inswing saddle handicap threshold Options: Mill Finish Jamb Notches Countersunk screw holes	
DB656SDL	A.D.A. Approved 6 9/16" wide x 1/2" high Inswing saddle handicap threshold Options: Mill Finish Jamb Notches Countersunk screw holes	



DLP DOOR COMPONENTS

Replacement Thresholds and Accessories

Making durable thresholds since 1987, DLP's threshold designs are built to last. Keeping the bugs and water out and the air in, DLP thresholds have been tested with several door systems to pass the stringent Florida building codes.

- DLP offers a full line of inswing, outswing, and ADA compliant aluminum thresholds
- Available in a variety of profiles
- Mill finish
- Manufactured in the USA
- Threshold profiles are not to a consistent scale, identify individually using dimensions

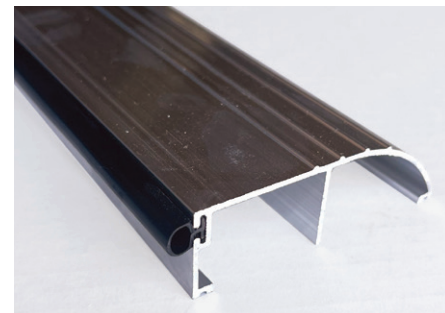

BUMPER REPLACEMENT THRESHOLD

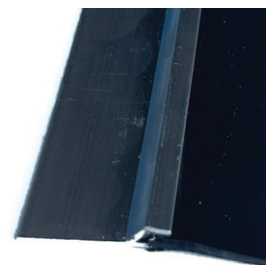

BUG SWEEP

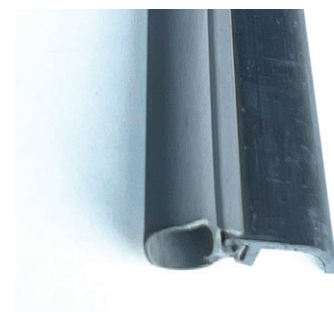

JAMB UP WEATHER STRIPPING

REPLACEMENT THRESHOLDS AND ACCESSORIES

PRODUCT	SPECIFICATIONS	FINISH	DIAGRAM
BUMPER Individually wrapped with Poly Tubing includes Screws	Low Bumper 3-1/8"W x 5/8"H	Mill Finish	
	High Bumper 3-1/8"W x 1"H	Mill and Bronze Finish	
SADDLE Individually wrapped with Poly Tubing includes Screws	Low Saddle 3-17/32"W x 11/16"H	Mill Finish	
	High Saddle 3-17/32"W x 15/16"H	Mill and Bronze Finish	
BUG SWEEP Bulk packed in boxes of 100	Black weatherstripping Comes standard at 36 1/2" long	Mill Finish	
JAMB-UP Wrapped with Poly Tubing in complete sets includes nails	Grey weatherstripping Comes standard for a 3/0 x 6/8 door	Mill Finish	
VINYL THRESHOLD TAPE ROLL	Roll is 5" x 100'	Black Finish	
SIDELITE SEAT For use with ISCS	Vinyl 8" - 37"	White Finish	
ASTRAGAL SLIDE BOLT RECEIVER For use with head jamb and threshold	Heavy Duty Plastic diameter/length 5/16" x 2"	Black Finish	
ISCS INSWING SCREWHOLE PLUGS	Heavy Duty Plastic	Mill, Bronze, or Black Finish	
THRESHOLD JAMB SEALS	Self-adhesive foam	Black Finish	

Length of thresholds can be specified



DLP DOOR COMPONENTS

Windsert Ventilating Doors

Windsert by DLP is an operational window door insert. This eliminates the need for a screen door. With the optional security screen, this allows for expedient ventilation without compromising on security. The Windsert is designed for patio doors, cabana bath doors, side garage doors, and is perfect for entry doors in beachside residences and condominiums.

- Superior ventilation
- Tested to the strict Florida building codes, including the High Velocity Hurricane Zone
- Optional security screen allows ventilation without compromising security. All Windserts come with standard non-security screen
- Manufactured in the USA
- Florida Product approval numbers 14803.1-.9 and 14805.1-.3

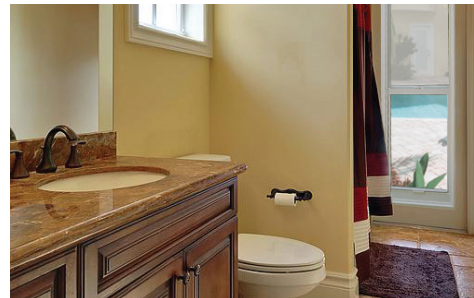

DOOR STYLES



6/8 Half-light



6/8 3/4-light



6/8 Full-light



8/0 Half-light



8/0 Full-light

CONFIGURATIONS

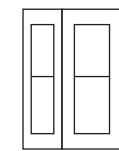

O X

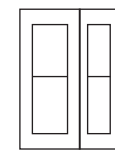

X O

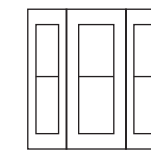

O X O

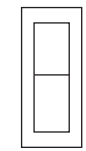

X

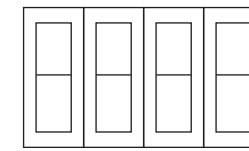

O X X O

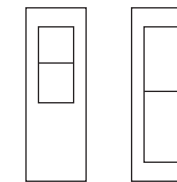

X X

GLASS OPTIONS

Representation only. Not actual colors.



Low E

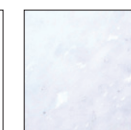

Milky White



Clear

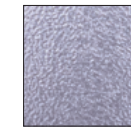

Obscure

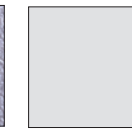

Gray



Turtle

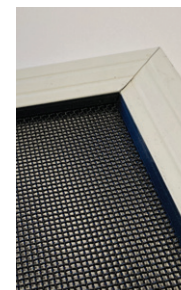

OPTIONAL SECURITY SCREEN

- High Tensile 304 Stainless Security mesh
 - Tight pattern for insect control
 - Rigid structure for impact deflection (passes hurricane impact test with window open)
- Windsert security screen is available for all door sizes

6/8 NON-IMPACT

WINDSERT OPTIONS			
Door Width	Glass Size	Windsert Size 6/8	Cut Out Size 6/8
2/0 and 2/4	HALF-LIGHT	14 X 36	13 1/2 x 37
	FULL-LIGHT	14 X 64	13 1/2 x 65
2/6	HALF-LIGHT	18 X 36	19 x 37
	FULL-LIGHT	18 X 64	19 x 65
2/8	HALF-LIGHT	20 X 36	21 x 37
	FULL-LIGHT	20 X 64	21 x 65
3/0	HALF-LIGHT	22 X 36	23 x 37
	3/4-LIGHT	22 X 48	23 x 49
	FULL-LIGHT	22 X 64	23 x 65

Not available in Low E, Milky White, or Turtle

6/8 IMPACT

WINDSERT OPTIONS			
Door Width	Glass Size	Windsert Size 6/8	Cut Out Size 6/8
2/0 and 2/4	HALF-LIGHT	14 X 36	13 1/2 x 37
	FULL-LIGHT	14 X 64	13 1/2 x 65
2/6	HALF-LIGHT	18 X 36	19 x 37
	FULL-LIGHT	18 X 64	19 x 65
2/8	HALF-LIGHT	20 X 36	21 x 37
	FULL-LIGHT	20 X 64	21 x 65
3/0	HALF-LIGHT	22 X 36	23 x 37
	3/4-LIGHT	22 X 48	23 x 49
	FULL-LIGHT	22 X 64	23 x 65

8/0 IMPACT

WINDSERT OPTIONS			
Door Width	Glass Size	Windsert Size 8/0	Cut Out Size 8/0
2/0 and 2/4	FULL-LIGHT	14 x 80	13 1/2 x 81
2/6	FULL-LIGHT	18 x 80	19 x 81
2/8	FULL-LIGHT	20 X 80	21 x 81
3/0	HALF-LIGHT	22 X 48	23 x 49
	FULL-LIGHT	22 X 80	23 x 81



PR PRESSRITE
TRACK AND HARDWARE

Pocket Doors

USE WITH 1" TO 1 3/4" DOORS WEIGHING UP TO 200LBS EACH.

This hardware set features our top-of-the-line ball bearing hangers. The adjustable 122 2-wheel ball-bearing hanger is used for doors up to 100lbs. and our 4-wheel ball-bearing hanger is used for doors up to 150lbs. **An additional 802 4-wheel ball-bearing roller can be added to the center of your door panel if there is a need to increase the capacity to 200lbs.** Our ball-bearing hangers operate smoother and more effortless than any in their class. This hardware is used in conjunction with our aluminum 800 track or our aluminum 1200 split-header track that allows for the track to be recessed directly into the header.

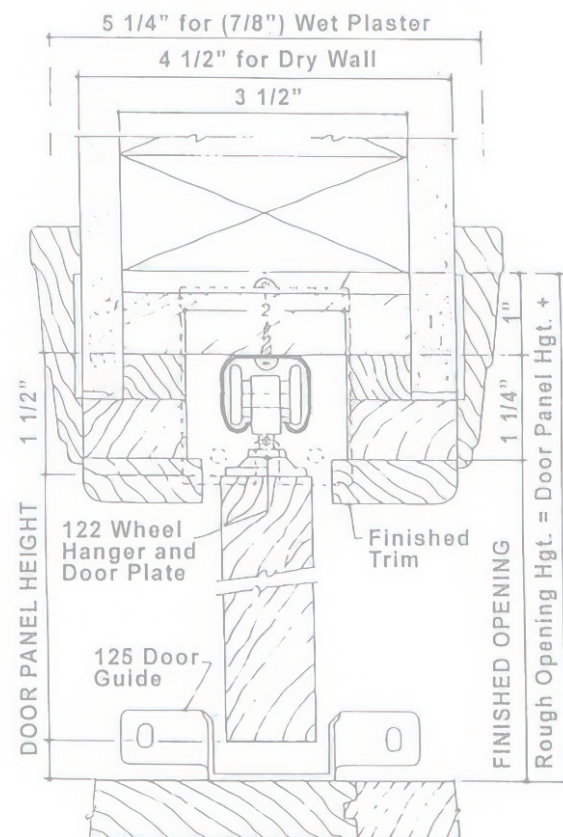

POCKET DOOR HARDWARE



800 Aluminum Track



122 2-Wheel Hanger With Door Plate



125 Nylon Door Guide



1200 Aluminum Track

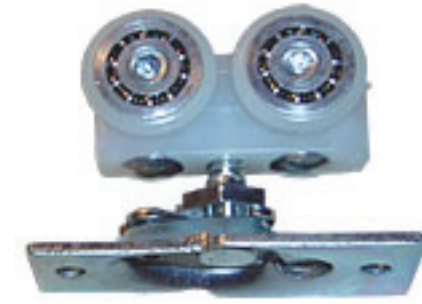

802 4-Wheel Hanger With Door Plate



704 Aligner / Wrench

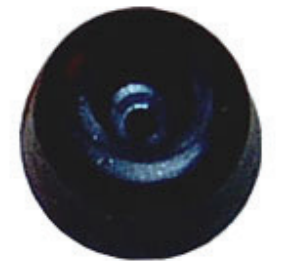

130 Rubber Bumper With Nail (Optional)

POCKET DOOR TRACK AND HARDWARE SETS

All parts can come in sets with floor guide, aligner/wrench, and your choice of track and door hangers.

OPTIONS			
TRACK	DOOR HANGER	FLOOR GUIDE	ALIGNER / WRENCH
800 Aluminum Track	122 2-Wheel Hanger With Door Plate	125 Nylon Door Guide	704 Aligner / Wrench
1200 Aluminum Track	802 4-Wheel Hanger With Door Plate		

Lengths of track up to 24'

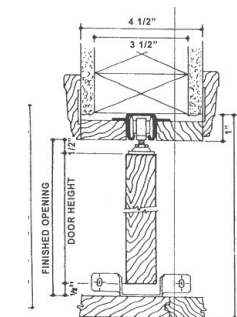

Series 1200 Track
Pocket Door Detail
Split Header Installation

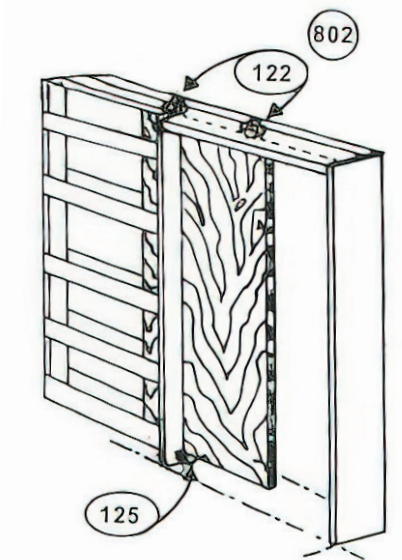



PR PRESSRITE
TRACK AND HARDWARE

Bi-Fold Doors

USE WITH 1" TO 1 3/4" DOORS WEIGHING UP TO 50 LBS PER PAIR OF PANELS

This is our standard bi-fold hardware and it is recommended for 2-door or 4-door openings. All of the hardware is inserted into the door edge and there is a 1/2" vertical adjustment.

- For closet doors, access doors or plantation shutters
- Uses aluminum track
- Manufactured in the USA

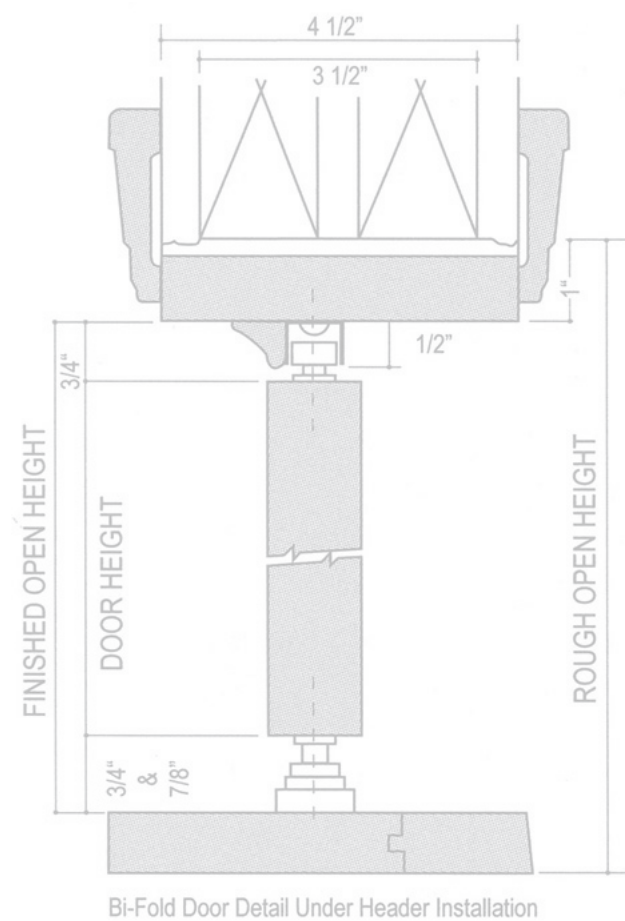

BI-FOLD TRACK & HARDWARE



780 Aluminum Track



775 Track Bracket



756 Jamb Floor Bracket

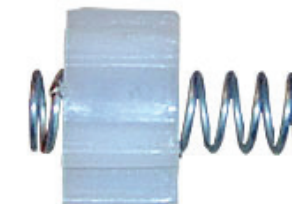

772 Short Snugger Spring

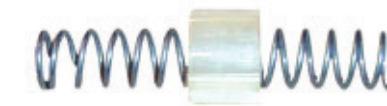

774 Long Snugger Spring



704 Aligner / Wrench (optional)



404 Non-Mortise 3-leaf (optional) Brass Plated Hinge



755 Nylon Bottom Pivot Finger



701 Nylon Top Pivot



702 Top Roller Pivot with Wheel



703 Natural Wood Knob 1 1/2" dia

404SN Satin Nickel Hinge available as a color option

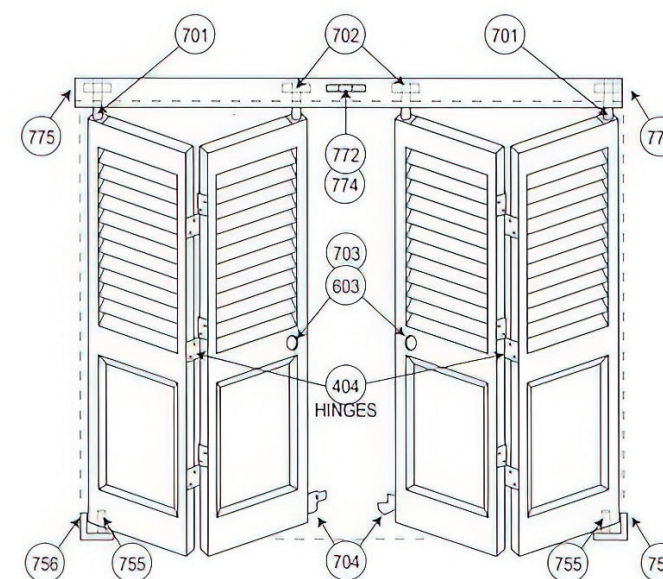

ITEM#	DESCRIPTION
2 DOOR TRACK	
780	SIZES: 1/6 – 3/0
2 DOOR BI-FOLD HARDWARE	
780222101 SET	SET INCLUDES: 701 Nylon Top Pivot 702 Top Roller Pivot with Wheel 703 Natural Wood Knob 1 1/2" 755 Nylon Bottom Pivot Finger Adjustable 756 Jamb Floor Bracket 772 Short Snugger Spring
1 SET REQUIRED PER TRACK	
4 DOOR TRACK	
780	SIZES: 4/0 – 6/0
4 DOOR BI-FOLD HARDWARE	
7802221A2 SET	SET INCLUDES: 701 Nylon Top Pivot 702 Top Roller Pivot with Wheel 704 Aligner/Wrench 703 Natural Wood Knob 1 1/2" 755 Nylon Bottom Pivot Finger Adjustable 756 Jamb Floor Bracket 772 Short Snugger Spring
2 SETS REQUIRED PER TRACK	



PR PRESSRITE
TRACK AND HARDWARE

HEAVY DUTY Bi-Fold Doors

USE WITH 1" TO 1 3/4" DOORS WEIGHING UP TO 150LBS PER PAIR OF PANELS.

This is our best quality hardware and it can be used with two-door, four-door, or multiple door units. The hardware set features our adjustable four-wheel ball-bearing hanger giving it a smoother and more effortless operation than any in its class. This hardware is used in conjunction with our aluminum 800 track.

- For closet doors, access doors or plantation shutters
- Uses aluminum track
- Manufactured in the USA

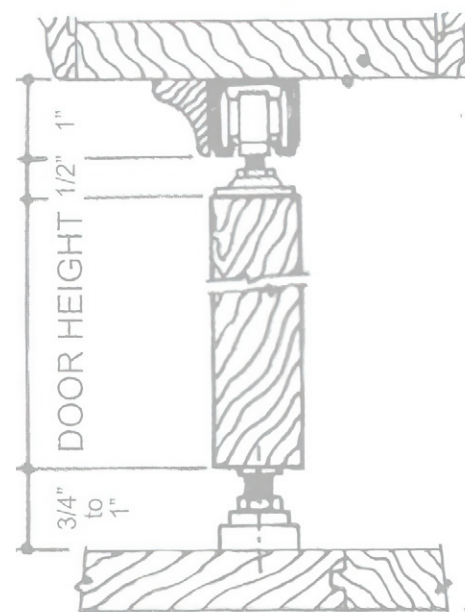

HEAVY DUTY BI-FOLD TRACK & HARDWARE



800 Aluminum Track



801 Track Bracket



715 Jamb Floor Bracket



704 Aligner / Wrench



404 Non-Mortise
3-leaf (optional)
Brass Plated Hinge



705 Nylon
Bottom Pivot



701 Nylon
Top Pivot



703 Natural Wood
Knob 1 1/2" dia



802 4-Wheel Ball Bearing
Roller with Door Plate

404SN
Satin Nickel Hinge
available as a
color option

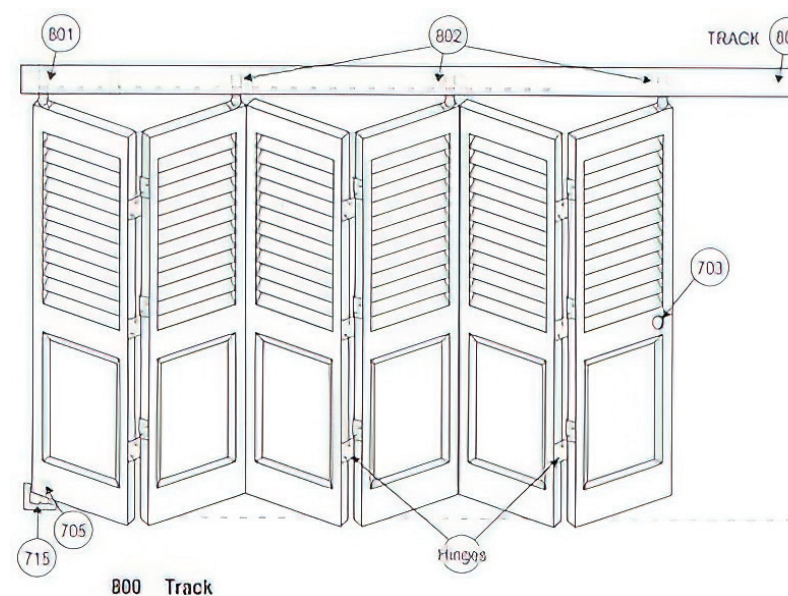

ITEM#	DESCRIPTION
2 DOOR TRACK	
800	SIZES: 1/6 – 3/0
2 DOOR BI-FOLD HARDWARE	
3502111 SET	SET INCLUDES: 701 Nylon Top Pivot 703 Natural Wood Knob 1 1/2" 704 Aligner/Wrench 705 Nylon Bottom Pivot 715 Jamb Floor Bracket 801 Track Bracket 802 4-Wheel Ball Bearing Roller with Door Plate
4 DOOR TRACK	
800	SIZES: 4/0 – 6/0
4 DOOR BI-FOLD HARDWARE	
3504111 SET	SET INCLUDES (x2 each): 701 Nylon Top Pivot 703 Natural Wood Knob 1 1/2" 704 Aligner/Wrench 705 Nylon Bottom Pivot 715 Jamb Floor Bracket 801 Track Bracket 802 4-Wheel Ball Bearing Roller with Door Plate



PR PRESSRITE
TRACK AND HARDWARE

ByPass Doors

USE WITH 1 3/8" DOORS WEIGHING UP TO 50LBS EACH.

This hardware features pivot-adjusting v-wheel hangers for smooth and quiet operation. This hardware is used in conjunction with our aluminum 235 and 245 track.

All parts can come in sets with door hangers and your option of track, floor guides, and finger pulls.

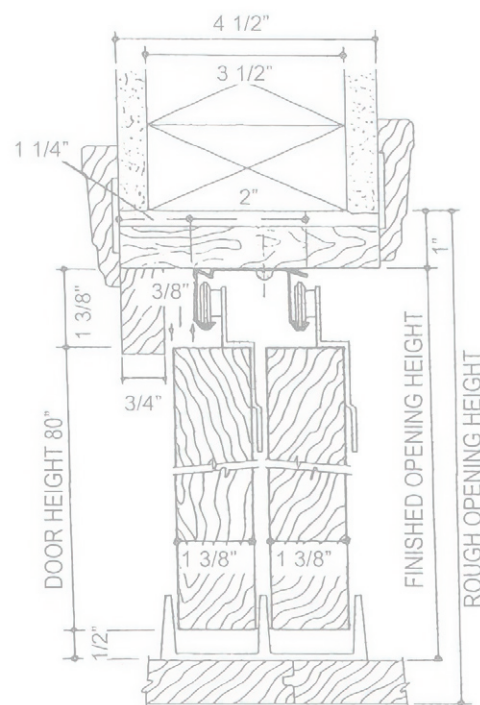

BY PASS TRACK & HARDWARE



235 Aluminum Track



228 Hanger, Vee-Wheel, Zinc Plated



209 Adjustable Floor Guide



245 Aluminum Track with Fascia



210 Floor Guide for 1 3/8" Doors



213 Brass Plated Finger Pull 3/4"



213N Nickel Plated Finger Pull 3/4"



216 Beige Plastic Pull 1 3/4"



218 Satin Nickel Pull - 2 1/8"

BY PASS TRACK AND HARDWARE SETS

All parts can come in sets with door hangers and your choice of track, floor guides, and finger pulls.

DOOR HANGER	OPTIONS		
	TRACK	FLOOR GUIDE	FINGER PULL
228 Hanger, Vee-Wheel, Zinc Plated	235 Aluminum Track	209 Adjustable Floor Guide	213 Brass Plated Finger Pull 3/4"
			213N Nickel Plated Finger Pull 3/4"
	245 Aluminum Track with Fascia	210 Floor Guide for 1 3/8" Doors	216 Beige Plastic Pull 1 3/4"
			218 Satin Nickel Pull - 2 1/8"

All By Pass track and hardware can be sold in bulk quantities or in prepackaged shrink wrapped sets.

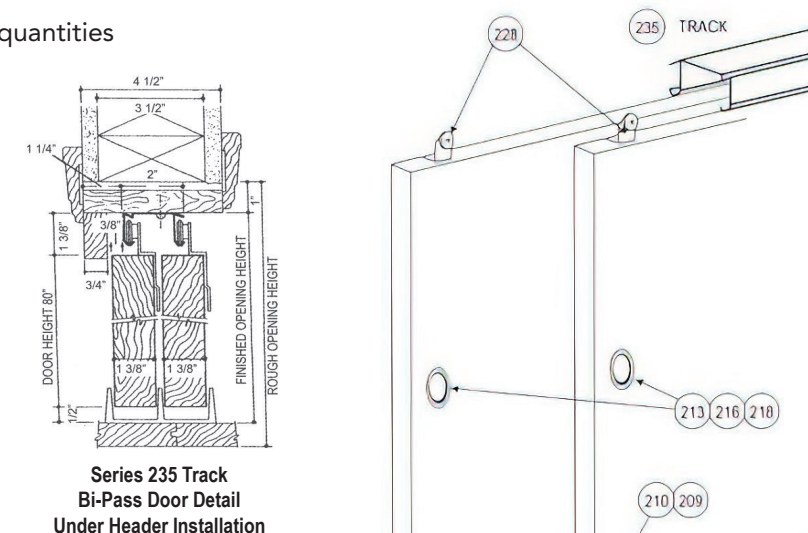



PR PRESSRITE
TRACK AND HARDWARE

SPLIT-HEADER PREMIUM By Pass Track & Hardware

USE WITH 1 3/8" DOORS WEIGHING UP TO 50LBS. EACH

This hardware features pivot-adjusting concave-wheel hangers with bronze bushings for smooth and quiet operation. This hardware is used in conjunction with our aluminum 221 track which is factory assembled with the track recessed between two strips of wood for a finished 4 1/2" header or our 222 track that allows you to insert your own wood to determine a custom header size.

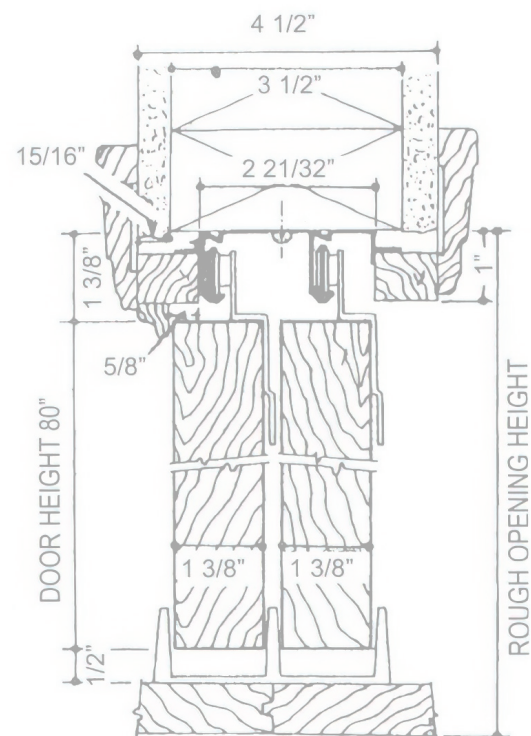

SPLIT-HEADER PREMIUM BY PASS TRACK & HARDWARE



230 Concave Wheel Hanger (with bronze bushing)



209 Adjustable Floor Guide



210 Floor Guide for 1 3/8" Doors



221 Aluminum Track (with wooden nailers)

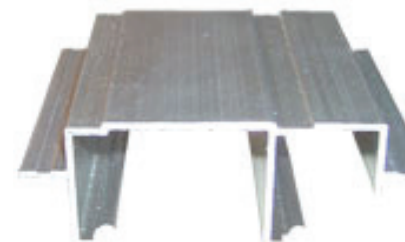

222 Aluminum Track (without wooden nailers)



213 Brass Plated Finger Pull 3/4"



213N Nickel Plated Finger Pull 3/4"



216 Beige Plastic Pull 1 3/4"



218 Satin Nickel Pull - 2 1/8"

SPLIT-HEADER PREMIUM BY PASS TRACK AND HARDWARE SETS

All parts can come in sets with door hangers and your choice of track, floor guides, and finger pulls.

OPTIONS			
DOOR HANGER	TRACK	FLOOR GUIDE	FINGER PULL
230 Concave Wheel Hanger (with bronze bushing)	221 Aluminum Track (with wooden nailers)	209 Adjustable Floor Guide	213 Brass Plated Finger Pull 3/4"
			213N Nickel Plated Finger Pull 3/4"
	222 Aluminum Track (without wooden nailers)		216 Beige Plastic Pull 1 3/4"
			218 Satin Nickel Pull - 2 1/8"

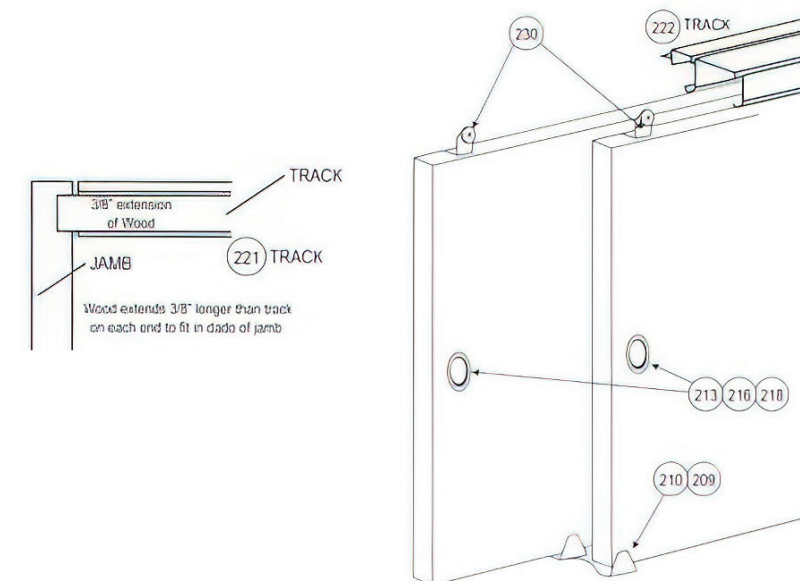



PR PRESSRITE
TRACK AND HARDWARE

HEAVY DUTY ByPass Doors

USE WITH 1 3/8" DOORS WEIGHING UP TO 200LBS EACH.

This is our best quality hardware and it can be used with two-door or multiple door units. The hardware set features our adjustable 2-wheel ball-bearing hanger for doors up to 100lbs. or our 4-wheel ball-bearing hanger for doors up to 150lbs. **An additional 802 4-wheel ball-bearing roller can be added to the center of your door panel if there is a need to increase the capacity to 200lbs.** Our ball bearing hangers operate smoother and more effortless than any in their class. This hardware is used in conjunction with our aluminum 2300 track.

All parts can come in sets with track and your option of door hangers, floor guides, and finger pulls.

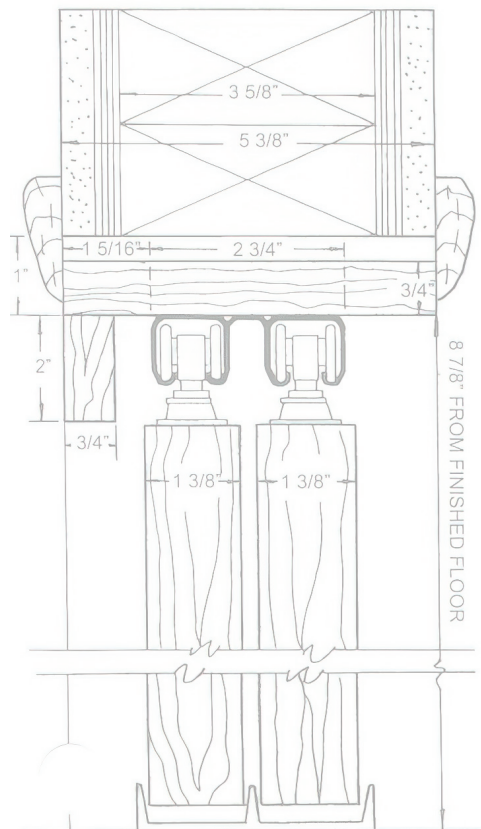

2300 Aluminum Track

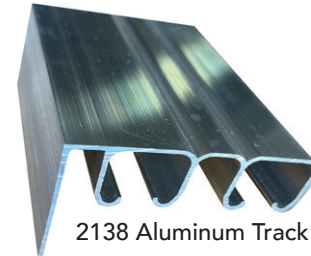

2138 Aluminum Track

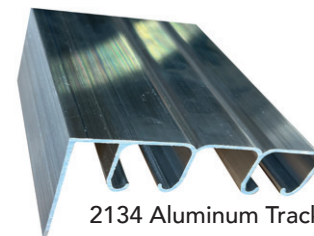

2134 Aluminum Track



800 Aluminum Track
(use x2 for bypass)

HEAVY DUTY BY PASS TRACK & HARDWARE



122 2-Wheel Hanger with Door Plate

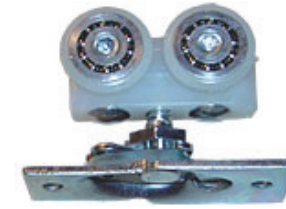

802 4-Wheel Hanger with Door Plate



209 Adjustable Floor Guide



210 Floor Guide for 1 3/8" Doors



213 Brass Plated Finger Pull 3/4"



213N Nickel Plated Finger Pull 3/4"



216 Beige Plastic Pull 1 3/4"



218 Satin Nickel Pull - 2 1/8"

HEAVY DUTY BYPASS TRACK AND HARDWARE SETS

All parts can come in sets with your choice of track, floor guides, door hangers, and finger pulls.

DOOR THICKNESS	TRACK	FLOOR GUIDE	OPTIONS	
			DOOR HANGER	FINGER PULL
1 3/8"	2300 Aluminum Track	209 or 210 Floor Guide	122 2-Wheel Hanger with Door Plate	213 Brass Plated Finger Pull 3/4"
	2138 Aluminum Track			213N Nickel Plated Finger Pull 3/4"
1 3/4"	2134 Aluminum Track	209 Adjustable Floor Guide	802 4-Wheel Hanger with Door Plate	216 Beige Plastic Pull 1 3/4"
				218 Satin Nickel Pull - 2 1/8"

All ByPass track and hardware can be sold in bulk quantities or in prepackaged shrink wrapped sets.



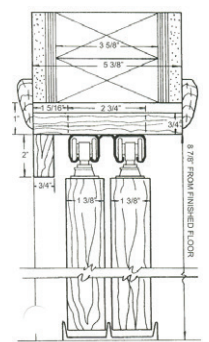

Finished Door Size*	2'0"	2'6"	3'0"
Overall Width	48 1/2"	60 1/2"	72 1/2"
Length of Track	47"	59"	71"
Width of Rough Opening	49"	61"	73"
Height of rough opening from finished floor	82 7/8"	82 7/8"	82 7/8"

*These measurements are for a 6" door, 1/2" floor clearance and 1" lap of doors

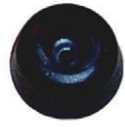

- All parts and pieces can be bought separately
- Hardware Bags can be purchased in bulk, or shrink wrapped to the track and ready for use

Pocket Header Bypass Hardware Sets

FOR USE WITH 800 OR 1200 TRACK					
	122	802	125	130	704
120	2		1	OPTIONAL	1
508		2	1	OPTIONAL	1

Hardware Bag Number

Quantity of Component

Component Part Number

Standard Bifold Hardware

FOR USE WITH 780 TRACK								
	701	702	703	704	755	756	772	775
2 DOOR								
780222101	1	1	1		1	1	1	
2 DOOR WITH ALIGNER								
(2 SETS = 4 DOORS)	1	1	1	1	1	1	1	
7802221A2								







Heavy Duty Bifold Hardware

FOR USE WITH 800 TRACK, Additional 800 track may be added for multitrack doors							
	802	701	703	704	705	715	801
2 DOOR 3502111	1	1	1	1	1	1	1
4 DOOR 3504111	2	2	2	2	2	2	2

Standard Bypass Hardware Sets

FOR USE WITH 235 & 245 TRACK							
	228	209	210	213	213N	216	218
2282111	4	1		2			
2282111N	4	1			2		
2282113	4	1					2
2282121	4		1	2			
2282121N	4		1		2		
2282123	4		1				2
2282112	4	1				2	
2282122	4		1			2	

Split-Header Bypass Hardware Sets

FOR USE WITH 221 OR 222 TRACK							
	230	209	210	213	213N	216	218
2282211	4	1		2			
2282211N	4	1			2		
2282212	4	1				2	
2282213	4	1					2
2282221	4		1	2			
2282221N	4		1		2		
2282222	4		1			2	
2282223	4		1				2

Heavy Duty Bypass Hardware Sets

FOR USE WITH 2-800 TRACKS, 2300, 2134 & 2138 TRACKS									
2 DOOR	802	122	209	210	213	213N	216	218	704
2302111	4		1		2				1
2302111N	4		1			2			1
2302112	4		1				2		1
2302113	4		1					2	1
2302121	4			1	2				1
2302121N	4			1		2			1
2302122	4			1			2		1
2302123	4			1				2	1
2302211		4	1		2				1
2302211N		4	1			2			1
2302212		4	1				2		1
2302213		4	1					2	1

Heavy Duty Multipass Hardware Sets

(FOR USE WITH 3-800 TRACKS, 1-2300 TRACK AND 1 800 TRACK, 1-2134 TRACK AND 1 800 TRACK OR 1-2138 TRACK AND 1-800 TRACK)									
3 DOOR	802	122	209	210	213	213N	216	218	704
2303111	6		2		3				1
2303111N	6		2			3			1
2303112	6		2				3		1
2303113	6		2					3	1
2303121	6			2	3				1
2303121N	6			2		3			1
2303122	6			2			3		1
2303123	6			2				3	1
2303211		6	2		3				1
2303211N		6	2			3			1
2303212		6	2				3		1
2303213		6	2					3	1





213 Brass Plated Finger Pull 3/4"



213N Nickel Plated Finger Pull 3/4"



216 Beige Plastic Pull 1 3/4"



218 Satin Nickel Pull - 2 1/8"

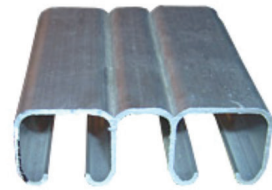

2300 Aluminum Track

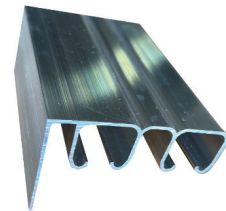

2138 Aluminum Track (Fascia Track for 1 3/8" Door Panels)

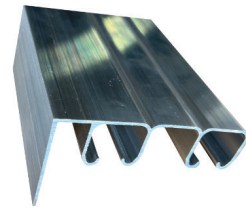

2134 Aluminum Track (Fascia Track for 1 3/4" Door Panels)



221 Aluminum Track (with wood nailers)



222 Aluminum Track (without wood nailers)



1200 Aluminum Track Split Header Track



125 Nylon Door Guide

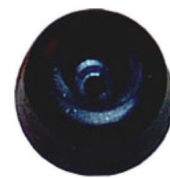

130 Rubber Bumper (optional)



Wholesale Supply

Are you a building materials distributor or dealer or builder in need of door components? We've got you covered. Depending on the volume, we can be ready to supply you as soon as today. We are proficient at stocking orders and special orders and can even drop ship to your customers. Our average lead time is two weeks on standard products.

Customer Specific Solutions

At DLP-PRESSRITE, we are all about the details. Let us know how you need your astragals, thresholds, and sliding door track prepped and we will take the variability out of your production line. From lock and deadbolt locations, to notches and punches, to pre-cutting your trim strips, we've got you covered. Your hardware will come ready to go with all the fasteners you need. That means simpler distribution and faster hassle-free installations.

Custom Ordered Hardware

Looking for a solution to your door component problem? DLP-PRESSRITE can meet all your hardware needs. Our research and development team can help design new profiles for your company. Please call for a consultation.

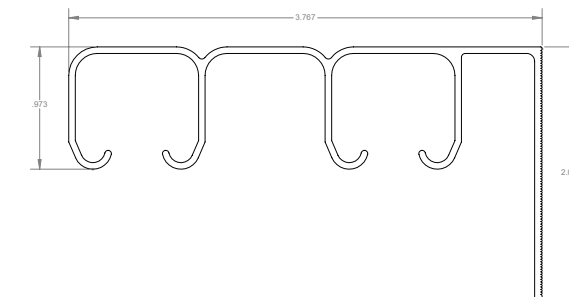
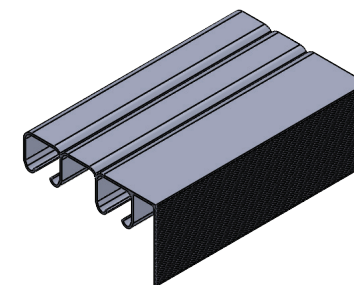

Have Questions?

Give us a call and we will get right on it or send us an email and we will get back to you as soon as possible. We are ready to serve your business from your production line to your customer service needs.

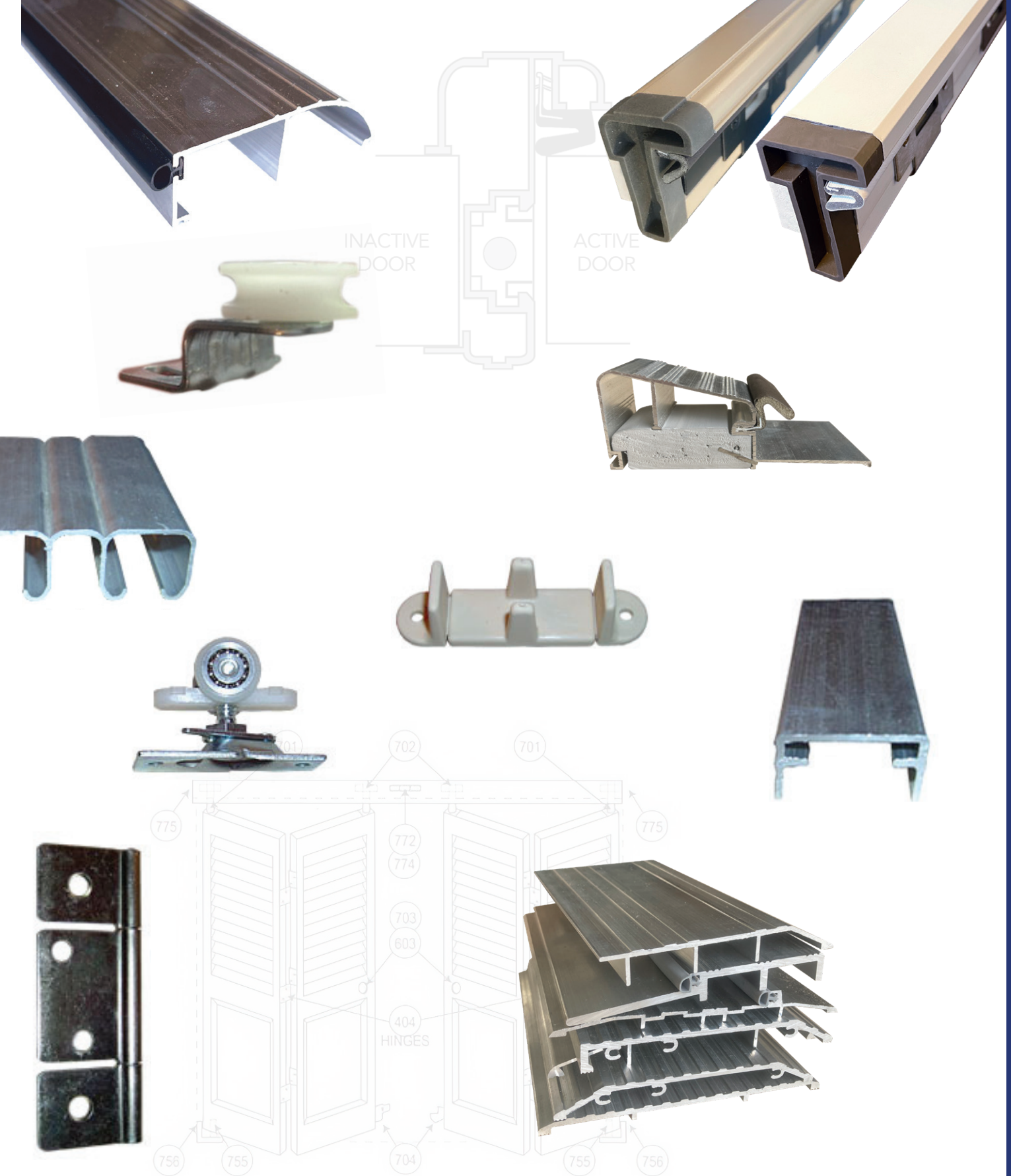

BHIDoors
SINCE 1963

1-800-966-7753
orders@bhitampa.com
www.bhiflorida.com