



DOOR SHOP COMPONENTS

you can *Trust.*



VOLUME 2

Builders
Hardware
Inc.

bhiflorida.com

Quality components

At BHI, we believe the use of quality components is the first step to producing best-in-class pre-hung units.

Builder's Hardware, Inc. (BHI), has always taken pride in using premium brands of components to create the best packages within its price range for the exterior and interior door pre-hanger.

BHI uses a handpicked list of components that stand the test of time, and endure the rigors of everyday use.

Quality...

Please also see our Plastpro Fiberglass Doors for the Doorshop and our ODL and Kenyon's Door Glass catalogs!

Industry respected...

- Door Frames by JM Eagle / Plastpro
- Thresholds, Astragals and Ventilating Windserts by DLP
- Security Three Point Locking Hardware by Trilennium
- And an extensive selection of assorted products: hardware, hinges, weather-stripping, door sweeps, finishing trim and brick-mold.

All created for real Florida living conditions.

Made in America...

JM Eagle/Plastpro, DLP, Trilennium, AirGuide, and Bommer are manufactured in the USA.

A majority of our system components are manufactured in the USA.

Builders
Hardware
Inc.

TRILENNIUM™



Q-LON®

AIRGUIDE

Loxscreen

Table of contents

FRAMES, MOLDINGS & MULLIONS	4-9
EXTERIOR DOOR ASTRAGALS	10-15
THRESHOLDS	16-23
VENTILATING INSERTS (WINDSERT)	24-25
HINGES	26-31
WEATHER SEALS	32-35
MULTI-POINT SECURITY HARDWARE	36-42
DOOR LOUVERS	43
SDL BARS	44
FLUSH BOLTS	45
BALL CATCHES AND DOOR VIEWER/KNOCKERS	46
DOOR VIEWER AND SHIPPING PRODUCTS	47



All products featured are stock items unless marked special order. Stock items subject to change.

BHIHinges



DLP INDUSTRIES

 plastpro® PF FRAMES™



FRAMES & MOLDINGS

plastpro® PF FRAMES™

Doorframes & Moldings

This rigid Poly Fiber formulation door jamb offers the very best in product performance, and is easy to use. Our innovative PF Frames can be machined like wood, look and feel like wood, and can be painted, faux finished or stained. The noticeable difference comes down to strength and durability.

The closed cellular structure of our composite frames ensures that the molding will not absorb moisture, and that the frame will resist splitting, rotting and insect damage.

- Closed Cellular Structure
- Twice The Screw-Holding Power of Wood
- Rigid Poly-Fiber Formulation – Composite
- Easily Machined
- Stocked Prepped (including weatherstrip) and Non-prepped



FRAMES & MOLDINGS SPECIFICATIONS FOR PREPPED JAMBS

HINGE JAMB 6/8

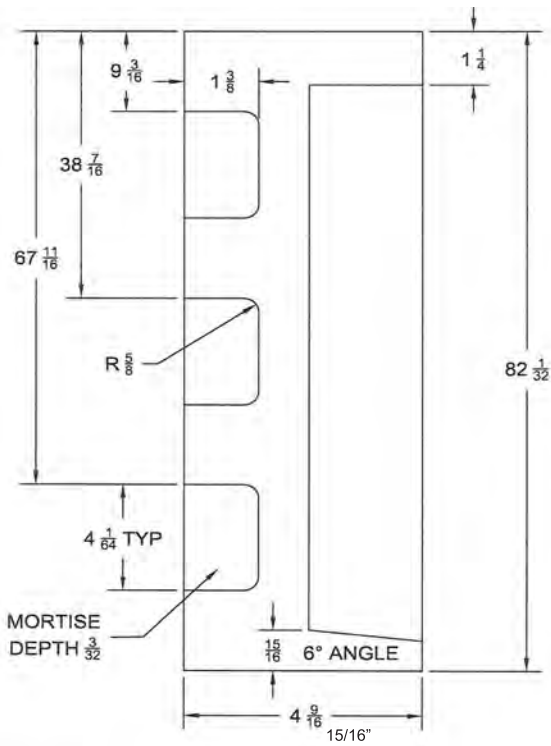

STRIKE JAMB 6/8

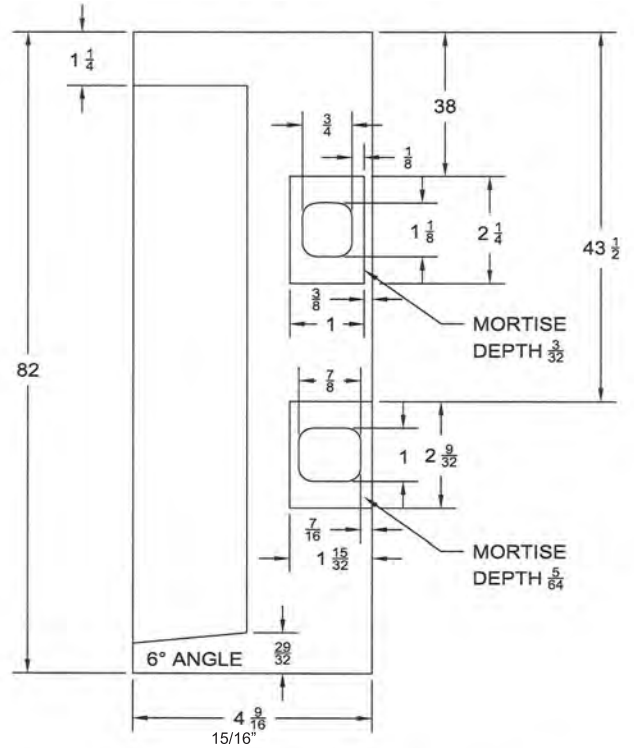

HINGE JAMB 8/0

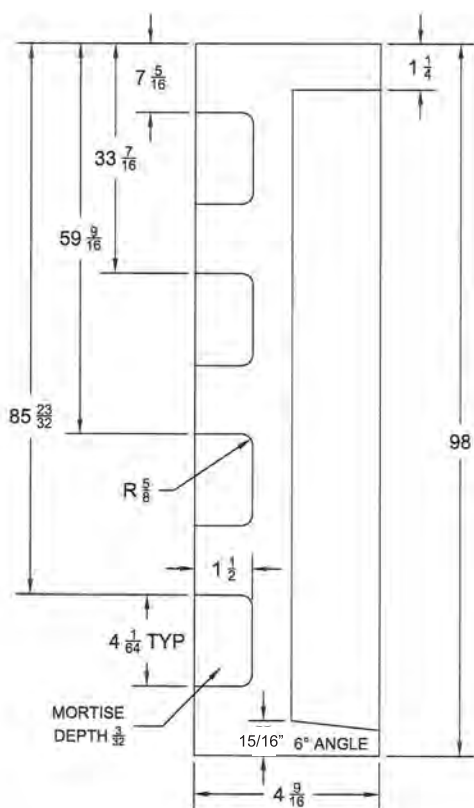

STRIKE JAMB 8/0

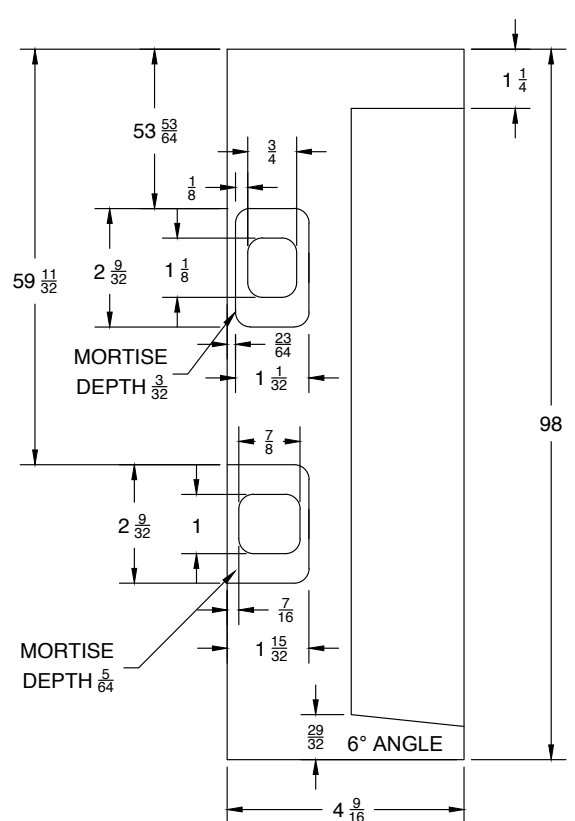

FRAMES & MOLDINGS

ALL FRAMES HAVE HEAD & SILL DADO

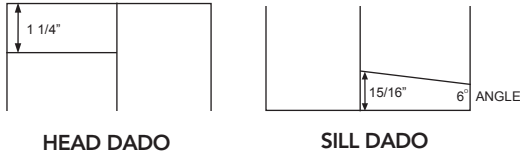

SMOOTH PRIMED WHITE PREPPED W/WEATHERSTRIP 4 -9/16"

SKU	SIZE	DESCRIPTION	FINISH	CASE PK
PFWHJ30	36 x 4-9/16	Smooth PF Header	White w/ White Qlon	50 / 160
PFWHJ60	72-9/16 x 4-9/16	Smooth PF Header	White w/ White Qlon	50 / 160
PFWHJL	82 x 4-9/16	Smooth PF Left Handed Hinge Prepped	White w/ White Qlon	50 / 160
PFWHJR	82 x 4-9/16	Smooth PF Right Handed Hinge Prepped	White w/ White Qlon	50 / 160
PFWHJL20MIN	82 x 4-9/16	20 Minute Fire Labeled Smooth PF Left Handed Hinge Prepped	White w/ White Qlon	50 / 160
PFWHJR20MIN	82 x 4-9/16	20 Minute Fire Labeled Smooth PF Right Handed Hinge Prepped	White w/ White Qlon	50 / 160
PFWLJLDB	82 x 4-9/16	Smooth PF Left Handed Latch & Deadbolt Prepped	White w/ White Qlon	50 / 160
PFWLJRDB	82 x 4-9/16	Smooth PF Right Handed Latch & Deadbolt Prepped	White w/ White Qlon	50 / 160
PFWHJR8	98 x 4-9/16	Smooth PF Right Handed Hinge Prepped	White w/ White Qlon	50 / 160
PFWHJL8	98 x 4-9/16	Smooth PF Left Handed Hinge Prepped	White w/ White Qlon	50 / 160
PFWLJL8	98 x 4-9/16	Smooth PF Left Handed Latch & Deadbolt Prepped	White w/ White Qlon	50 / 160
PFWLJR8	98 x 4-9/16	Smooth PF Right Handed Latch & Deadbolt Prepped	White w/ White Qlon	50 / 160

ALL FRAMES HAVE HEAD & SILL DADO

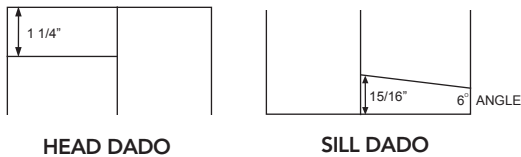

BLANK SMOOTH PRIMED WHITE 4 -9/16"

Blank door frames do not come with weatherstripping

SKU	SIZE	DESCRIPTION	FINISH	CASE PK
PFWSLJ	82 x 4-9/16	Blank Smooth Primed PF Jamb	White	50 / 160
PFWSLJ8	98 x 4-9/16	Blank Smooth Primed PF Jamb	White	50 / 160

FRAMES & MOLDINGS



ALL FRAMES HAVE HEAD & SILL DADO

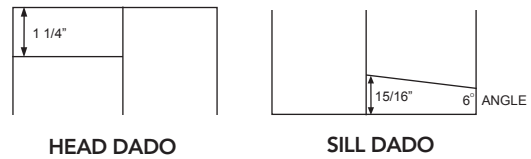

SMOOTH PRIMED WHITE PREPPED W/WEATHERSTRIP 5 -1/4"

SKU	SIZE	DESCRIPTION	FINISH	CASE PK
PFWHJ305	36 x 5-1/4	Smooth PF Header Jamb	White w/ White Qlon	35 / 70
PFWHJL5	82 x 5-1/4	Smooth PF Left Handed Hinge Prepped Jamb	White w/ White Qlon	35 / 70
PFWHJR5	82 x 5-1/4	Smooth PF Right Handed Hinge Prepped Jamb	White w/ White Qlon	35 / 70
PFWLJL5DB	82 x 5-1/4	Smooth PF Left Handed Latch & Deadbolt Prepped Jamb	White w/ White Qlon	35 / 70
PFWLJR5DB	82 x 5-1/4	Smooth PF Right Handed Latch & Deadbolt Prepped Jamb	White w/ White Qlon	35 / 70

BLANK SMOOTH PRIMED WHITE 5 -1/4"

Blank door frames do not come with weatherstripping

SKU	SIZE	DESCRIPTION	FINISH	CASE PK
PFWSLJ5	82 x 5-1/4	Blank Smooth Primed PF Jamb	White	35 / 70
PFWSLJ85	98 x 5-1/4	Blank Smooth Primed PF Jamb	White	35 / 70

SMOOTH PRIMED WHITE PREPPED W/WEATHERSTRIP 6 -9/16"

SKU	SIZE	DESCRIPTION	FINISH	CASE PK
PFWHJL6	82" x 6-9/16"	Smooth PF Left Handed Hinge Prepped Jamb	White w/ White Qlon	50 / 96
PFWHJR6	82" x 6-9/16"	Smooth PF Right Handed Hinge Prepped Jamb	White w/ White Qlon	50 / 96
PFWLJL6DB	82" x 6-9/16"	Smooth PF Left Handed Latch & Deadbolt Prepped Jamb	White w/ White Qlon	50 / 96
PFWLJR6DB	82" x 6-9/16"	Smooth PF Right Handed Latch & Deadbolt Prepped Jamb	White w/ White Qlon	50 / 96

BLANK SMOOTH PRIMED WHITE 6 -9/16"

Blank door frames do not come with weatherstripping

SKU	SIZE	DESCRIPTION	FINISH	CASE PK
PFWSLJ6	82" x 6-9/16"	Blank Smooth Primed PF Jamb	White	50 / 96
PFWSLJ86	98" x 6-9/16"	Blank Smooth Primed PF Jamb	White	50 / 96

BLANK SMOOTH PRIMED WHITE 7 -1/4"

Blank door frames do not come with weatherstripping

SKU	SIZE	DESCRIPTION	FINISH	CASE PK
PFWSLJ87	98" x 7-1/4"	Blank Smooth Primed PF Jamb	White	50 / 80

FRAMES & MOLDINGS

ALL FRAMES HAVE HEAD & SILL DADO

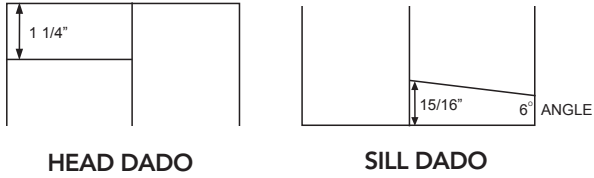

BLANK TEXTURED (ALL SIZES)

Blank door frames do not come with weatherstripping

SKU	SIZE	DESCRIPTION	FINISH	CASE PK
PFSLJ	82"x4-9/16"	Blank Textured PF	Tan	50 / 160
PFSLJ5	82"x5-1/4"	Blank Textured PF	Tan	35 / 70
PFSLJ6	82"x6-9/16"	Blank Textured PF	Tan	50 / 96
PFSLJ8	98"x4-9/16"	Blank Textured PF	Tan	50 / 160
PFSLJ85	98"x5-1/4"	Blank Textured PF	Tan	35 / 70
PFSLJ86	98"x6-9/16"	Blank Textured PF	Tan	50 / 96
PFSLJ87	98"x7-1/4"	Blank Textured PF	Tan	50 / 80

SECURITY STRIKE PLATES

(FOR USE WITH HVHZ SINGLE DOOR UNITS)

SKU	DESCRIPTION	FINISH	CASE PK
YR02081BLACK	1-1/4"x3-5/8" DEADBOLT SECURITY STRIKE	BLACK	12
YR02081US26	1-1/4"x3-5/8" DEADBOLT SECURITY STRIKE	BRIGHT CHROME	12

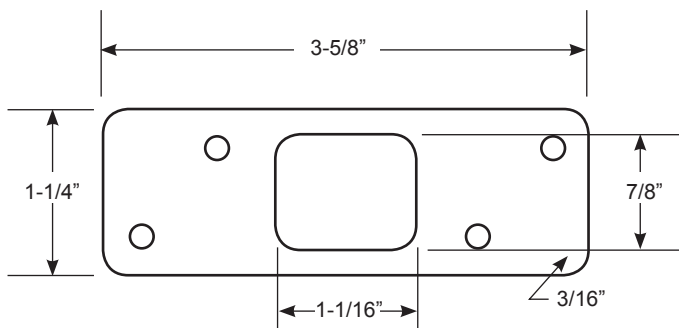

FRAMES, MOLDINGS & MULLIONS

BRICKMOLD AND MOLDING SMOOTH



SKU	SIZE	DESCRIPTION	FINISH	CASE PK
PFWBM17685	85"x1-1/2"x5/8"	Smooth PF Brickmold	White	50 / 800
PFWBM176102	102"x1-1/2"x5/8"	Smooth PF Brickmold	White	50 / 800
PFWBM18085	85" x 3/16"x2"	Smooth PF Brickmold	White	50 / 400
PFWBM180102	102"x1-3/16"x2"	Smooth PF Brickmold	White	50 / 400
PFMTS24M10000	100"x2-1/2"	Smooth PF Mullion Strip	White	80/1280
PFWSSM100	100"x11/32"x9/16"	Smooth PF Sidelite Stop Molding	White	55/1100

BRICKMOLD AND MOLDING TEXTURED



SKU	SIZE	DESCRIPTION	FINISH	CASE PK
PFBM176102	102"x1-1/2"x5/8"	Textured PF Brickmold	Tan	50 / 800
PFBM180102	102"x1-3/16"x2"	Textured PF Brickmold	Tan	50 / 400
PFMTG24M10000	100"x2-1/2"	Textured PF Mullion Strip	Tan	80 / 1280
PFSSM100	100"x11/32"x9/16"	Textured PF Sidelite Stop Molding	Tan	55 / 1100

BOTTOM RAIL



SKU	SIZE	DESCRIPTION	CASE PK
CRRLT3000	1.585 x 1.25 x 34.905	REPLACEMENT RAIL for PLASTPRO STANDARD SLABS 3/0 or LESS	350
CRRLT3000IP	1.485 x 1.25 x 34.905	REPLACEMENT RAIL for PLASTPRO IMPACT (IR) SLABS 3/0 or LESS	350

STRUCTURAL MULLION



SKU	SIZE	DESCRIPTION	CASE PK
MULL1414RECP12W	1" x 4" x 1/4" x 12'	Aluminum White	1
MULLCLIP1	3 3/8" X 8 1/4"	Aluminum (Works with MULL1414) Each Mullion requires 2 clips	1
MULL2614RECP12W	2" x 6" x 1/4" x 12'	Aluminum White	1
MULLCLIP2	3 3/8" X 5 1/2"	Aluminum (Works with MULL2614) Each Mullion requires 2 clips	1

EXTERIOR ASTRAGALS



Aluminum Astragals

DLP INDUSTRIES, INC.

Aluminum exterior door T-astragals that offer security, and also stand out with honor among the best under Florida building code testing.

Features:

- Slide bolt with patented flip lever locking for security
- 4 way adjustable strikes
- Pin point punch
- Finish ability- Low priced-easy to stain option
- Available in white, bronze and tan stainable

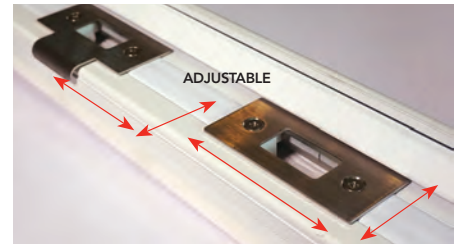

4-way adjustable (horizontal and vertical) strike latch plates



Flip lever locks

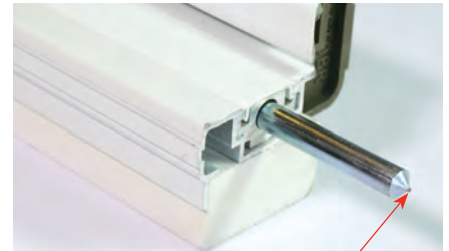

New slide bolt with machined center punch allows for precise bolt location and ease of installation.

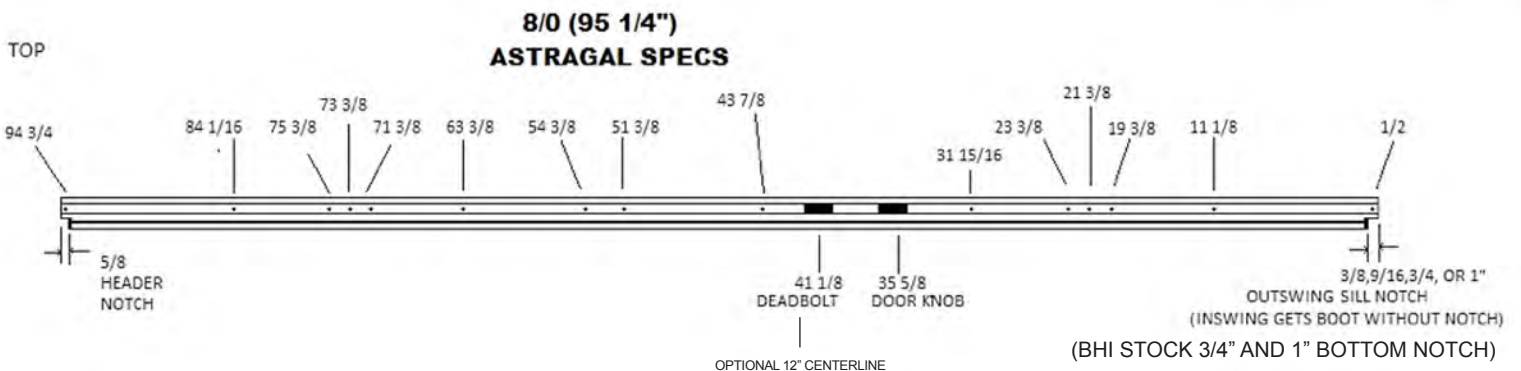
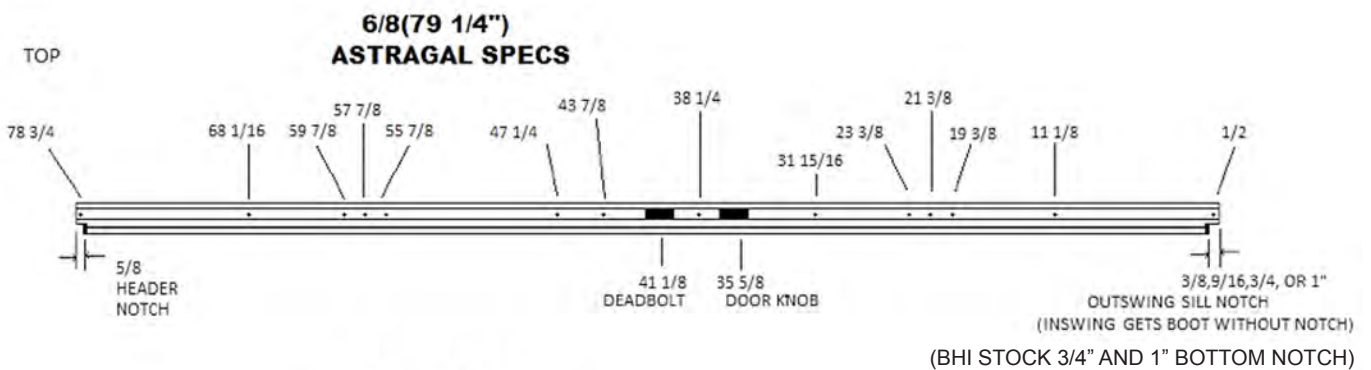

EXTERIOR ASTRAGALS

Add on an Astragal Security Strip to any outswing double door combination for added security and clean finished appearance eliminating the reveal between the doors.

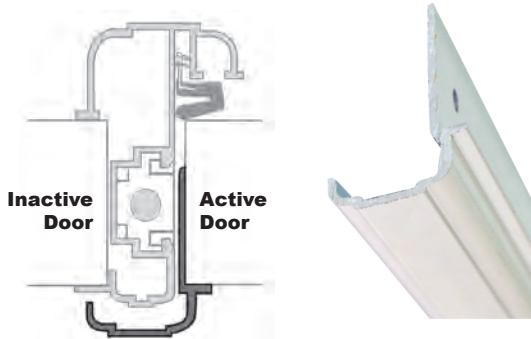

ASTRAGAL SECURITY STRIP

SKU	DESCRIPTION	FINISH	CASE PK
ASTSS68LOS	6/8 Astragal Security Strip for Left Hand Outswing Door	White	6 / 18
ASTSS68ROS	6/8 Astragal Security Strip for Right Hand Outswing Door	White	6 / 18
ASTSS80LOS	8/0 Astragal Security Strip for Left Hand Outswing Door	White	6 / 18
ASTSS80ROS	8/0 Astragal Security Strip for Right Hand Outswing Door	White	6 / 18

ALL ASTRAGALS HAVE SILL AND HEAD NOTCH

STOCK SIZE NOTCHES LISTED BELOW
(EXCEPT FOR INSWING ASTRAGALS WHICH ONLY HAVE HEAD NOTCH)

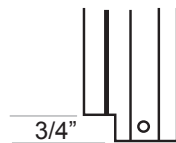

OUTSWING
SILL NOTCH

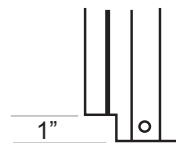

OUTSWING
SILL NOTCH

SPECIAL SIZE NOTCHES AVAILABLE

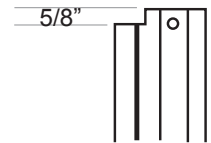

OUTSWING
& INSWING
HEAD
NOTCH



6/8 WHITE STANDARD STRIKE

SKU	DESCRIPTION	FINISH	CASE PK
AST68LISW	79-5/16" Astragal Left Hand Inswing	White w/ White Qlon	6 / 18
AST68RISW	79-5/16" Astragal Right Hand Inswing	White w/ White Qlon	6 / 18
AST68LOSW	79-5/16" Astragal Left Hand Outswing	White w/ White Qlon	6 / 18
AST68ROSW	79-5/16" Astragal Right Hand Outswing	White w/ White Qlon	6 / 18

SPECIAL SIZES AND SPECIFICATIONS AVAILABLE BY SPECIAL ORDER.

EXTERIOR ASTRAGALS

ALL ASTRAGALS HAVE SILL AND HEAD NOTCH

STOCK SIZE NOTCHES LISTED BELOW
(EXCEPT FOR INSWING ASTRAGALS WHICH ONLY HAVE HEAD NOTCH)

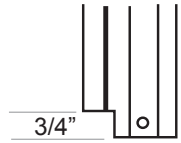

OUTSWING
SILL NOTCH

SPECIAL SIZE NOTCHES AVAILABLE

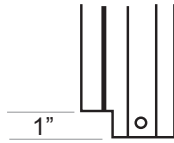

OUTSWING
SILL NOTCH

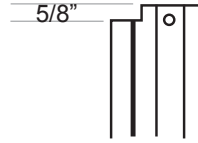

OUTSWING
& INSWING
HEAD
NOTCH

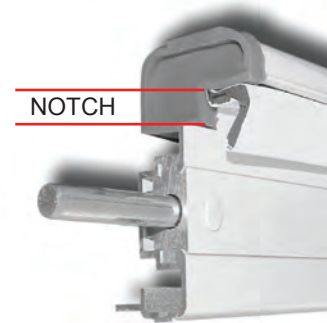

8/0 WHITE STANDARD STRIKE

SKU	DESCRIPTION	FINISH	CASE PK
AST80LISW	95-5/16" Astragal Left Hand Inswing	White w/ White Qlon	6 / 18
AST80RISW	95-5/16" Astragal Right Hand Inswing	White w/ White Qlon	6 / 18
AST80LOSW	95-5/16" Astragal Left Hand Outswing	White w/ White Qlon	6 / 18
AST80ROSW	95-5/16" Astragal Right Hand Outswing	White w/ White Qlon	6 / 18

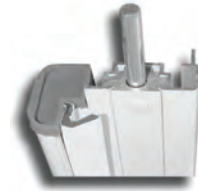

NON-HANDED WHITE STANDARD STRIKE

SKU	DESCRIPTION	FINISH	CASE PK
AST68NOHAND	80" Astragal Non-Handed No Sill or Head Notch	White w/ White Qlon	6 / 18
AST80NOHAND	95-5/16" Astragal Non-Handed No Sill or Head Notch	White w/ White Qlon	6 / 18



SPECIAL SIZES AND SPECIFICATIONS AVAILABLE BY SPECIAL ORDER.

EXTERIOR ASTRAGALS

ALL ASTRAGALS HAVE SILL AND HEAD NOTCH

STOCK SIZE NOTCHES LISTED BELOW
(EXCEPT FOR INSWING ASTRAGALS WHICH ONLY HAVE HEAD NOTCH)

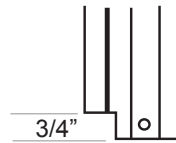

OUTSWING
SILL NOTCH

SPECIAL SIZE NOTCHES AVAILABLE

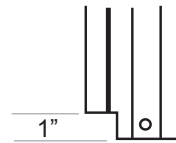

OUTSWING
SILL NOTCH

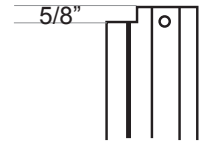

OUTSWING
& INSWING
HEAD
NOTCH



6/8 WHITE ADJUSTABLE STRIKE

SKU	DESCRIPTION	FINISH	CASE PK
AST68LISW-ASP	79-5/16" Adj Strike Astragal Left Hand Inswing	White w/ White Qlon	6 / 18
AST68RISW-ASP	79-5/16" Adj Strike Astragal Right Hand Inswing	White w/ White Qlon	6 / 18
AST68LOSW-ASP	79-5/16" Adj Strike Astragal Left Hand Outswing	White w/ White Qlon	6 / 18
AST68ROSW-ASP	79-5/16" Adj Strike Astragal Right Hand Outswing	White w/ White Qlon	6 / 18

SKU	DESCRIPTION	FINISH	CASE PK
AST68LOSW78-ASP	78" Adj Strike Astragal Left Hand Outswing	White w/ White Qlon	6 / 18
AST68ROSW78-ASP	78" Adj Strike Astragal Right Hand Outswing	White w/ White Qlon	6 / 18



6/8 STAINABLE PRIMED ADJUSTABLE STRIKE

SKU	DESCRIPTION	FINISH	CASE PK
ASTS68LISB-ASP	79-5/16" Adj Strike Astragal Left Hand Inswing	Tan w/ Bronze Qlon	6 / 18
ASTS68RISB-ASP	79-5/16" Adj Strike Astragal Right Hand Inswing	Tan w/ Bronze Qlon	6 / 18
ASTS68LOSB-ASP	79-5/16" Adj Strike Astragal Left Hand Outswing	Tan w/ Bronze Qlon	6 / 18
ASTS68ROSB-ASP	79-5/16" Adj Strike Astragal Right Hand Outswing	Tan w/ Bronze Qlon	6 / 18

SPECIAL SIZES AND SPECIFICATIONS AVAILABLE BY SPECIAL ORDER.

EXTERIOR ASTRAGALS

ALL ASTRAGALS HAVE SILL AND HEAD NOTCH

STOCK SIZE NOTCHES LISTED BELOW
(EXCEPT FOR INSWING ASTRAGALS WHICH ONLY HAVE HEAD NOTCH)

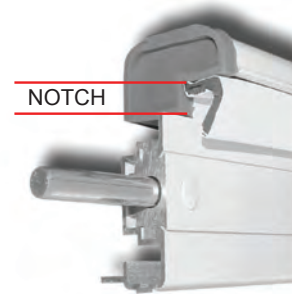
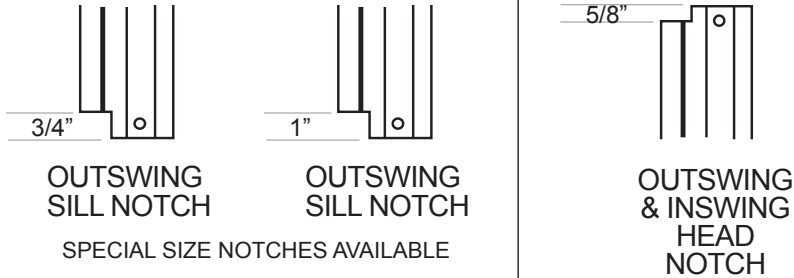

8/0 WHITE ADJUSTABLE STRIKE

SKU	DESCRIPTION	FINISH	CASE PK
AST80LISW-ASP	95-5/16" Adj Strike Astragal Left Hand Inswing	White w/ White Qlon	6 / 18
AST80RISW-ASP	95-5/16" Adj Strike Astragal Right Hand Inswing	White w/ White Qlon	6 / 18
AST80LOSW-ASP	95-5/16" Adj Strike Astragal Left Hand Outswing	White w/ White Qlon	6 / 18
AST80ROSW-ASP	95-5/16" Adj Strike Astragal Right Hand Outswing	White w/ White Qlon	6 / 18



8/0 STAINABLE PRIMED ADJUSTABLE STRIKE

SKU	DESCRIPTION	FINISH	CASE PK
ASTS80LISB-ASP	95-5/16" Adj Strike Astragal Left Hand Inswing	Tan w/ Bronze Qlon	6 / 18
ASTS80RISB-ASP	95-5/16" Adj Strike Astragal Right Hand Inswing	Tan w/ Bronze Qlon	6 / 18
ASTS80LOSB-ASP	95-5/16" Adj Strike Astragal Left Hand Outswing	Tan w/ Bronze Qlon	6 / 18
ASTS80ROSB-ASP	95-5/16" Adj Strike Astragal Right Hand Outswing	Tan w/ Bronze Qlon	6 / 18



6/8 & 8/0 TRILENNIUM PREPPED ASTRAGALS

SEE PAGES 36-42.

SKU	DESCRIPTION	FINISH	CASE PK
AST68LISW/WFP	79-5/16" Trilennium Prepped Astragal Left Hand Inswing	White w/ White Qlon	6 / 18
AST68RISW/WFP	79-5/16" Trilennium Prepped Astragal Right Hand Inswing	White w/ White Qlon	6 / 18
AST80LISW/WFP	95-5/16" Trilennium Prepped Astragal Left Hand Inswing	White w/ White Qlon	6 / 18
AST80RISW/WFP	95-5/16" Trilennium Prepped Astragal Right Hand Inswing	White w/ White Qlon	6 / 18



Stainable version is available.

SPECIAL SIZES AND SPECIFICATIONS AVAILABLE BY SPECIAL ORDER.

EXTERIOR ASTRAGALS

ASTRAGAL PARTS

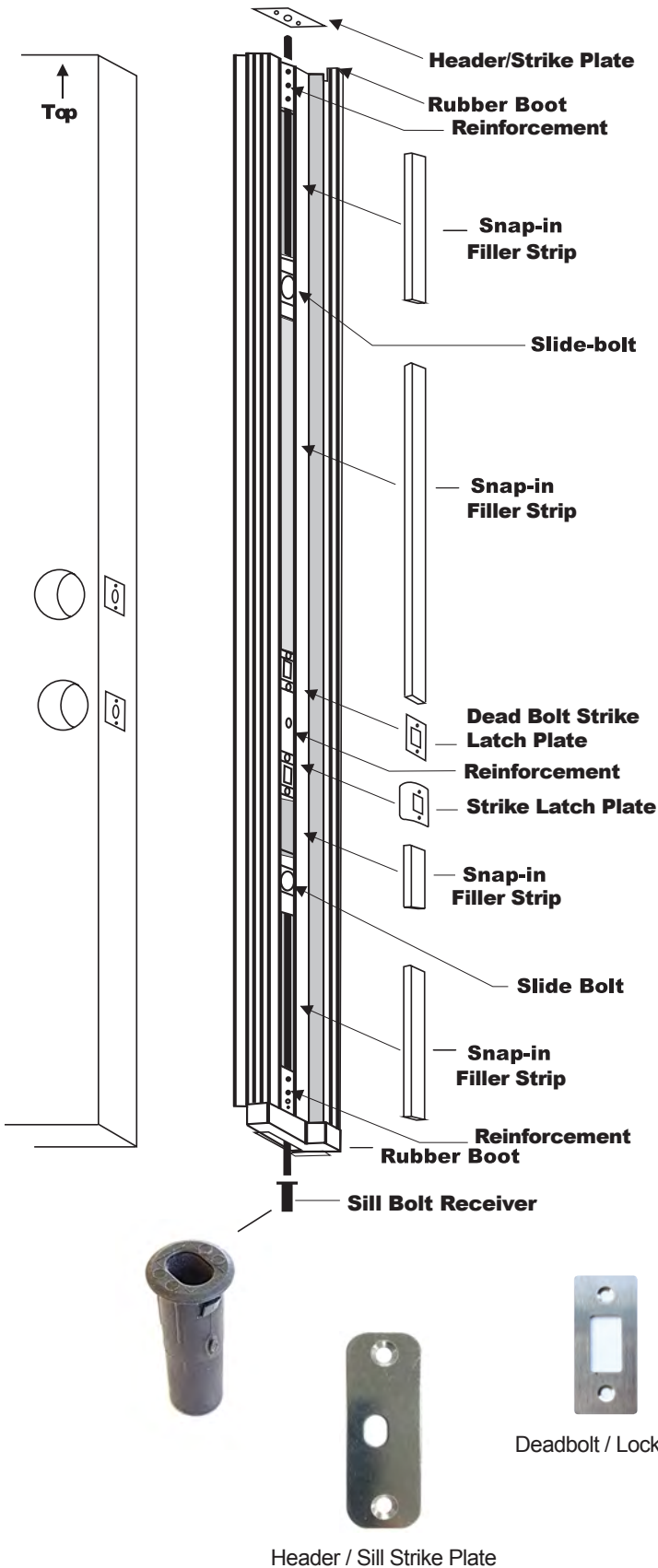

SKU	DESCRIPTION	FINISH	CASE PK
ASTHSS	Astragal Header/ Sill Strike Plate	Dull Chrome	6 / 18
ASTHW	Astragal Boot Hardware Bag	----	6 / 18
ASTFS86	86" Astragal Filler Strip	White	6 / 18
ASTFSB86	86" Astragal Filler Strip	Bronze	6 / 18
ASTFSHW	Astragal Filler Strip Hardware Bag	White	6 / 18
ASTGLLG	Astragal Glue 4 oz Bottle	Clear	6 / 18
ASTASPDBB	Adjustable Strike Deadbolt Latch Plate	Oil Rubbed Bronze	6 / 18
ASTASPDBS	Adjustable Strike Deadbolt Latch Plate	Satin Nickel	6 / 18
ASTASPKB	Adjustable Strike Lock Latch Plate	Oil Rubbed Bronze	6 / 18
ASTASPKS	Adjustable Strike Lock Latch Plate	Satin Nickel	6 / 18
ASTISBL	Astragal Boot Left Hand Inswing	Grey	6 / 18
ASTISBR	Astragal Boot Right Hand Inswing	Grey	6 / 18
ASTOSBL	Astragal Boot Left Hand Outswing	Grey	6 / 18
ASTOSBR	Astragal Boot Right Hand Outswing	Grey	6 / 18
ASTSBP	Astragal Slide Bolt Flip Lever	White	6 / 18
ASTSBR	Astragal Slide Bolt Receiver	Black	6 / 18



ASTHW – Astragal Boot Hardware Bag Includes:
 Glue
 Boots (top and bottom)
 Stiffeners
 Screws

THRESHOLDS



DLP INDUSTRIES, INC.

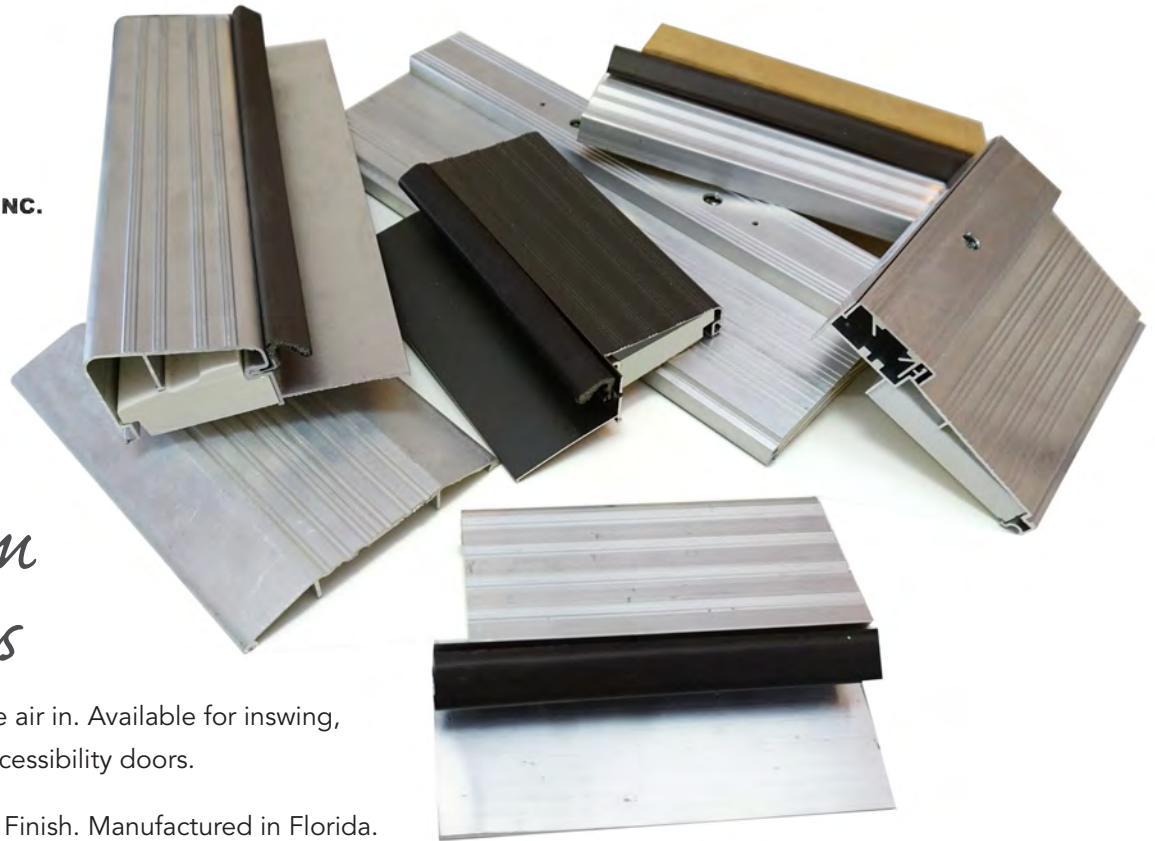

Aluminum Thresholds

Keep the bugs out and the air in. Available for inswing, outswing and handicap accessibility doors.

Available in Bronze or Mill Finish. Manufactured in Florida.

BUMPER AND SADDLE THRESHOLDS

Outswing Low Bumper			
SKU	DESCRIPTION	FINISH	CASE PK
LB30	36-1/2" Length Aluminum	Mill	15
LB60	72-1/2" Length Aluminum	Mill	15
Outswing High Bumper			
SKU	DESCRIPTION	FINISH	CASE PK
HB28	32-1/2" Length Aluminum	Mill	15
HB30	36-1/2" Length Aluminum	Mill	15
HB60	72-1/2" Length Aluminum	Mill	15
HB30B	36-1/2" Length Aluminum	Bronze	15
HB60B	72-1/2" Length Aluminum	Bronze	15
Inswing Low Saddle			
SKU	DESCRIPTION	FINISH	CASE PK
LS30	36-1/2" Length Aluminum	Mill	15
LS60	72-1/2" Length Aluminum	Mill	15
Inswing High Saddle			
SKU	DESCRIPTION	FINISH	CASE PK
HS30	36-1/2" Length Aluminum	Mill	15

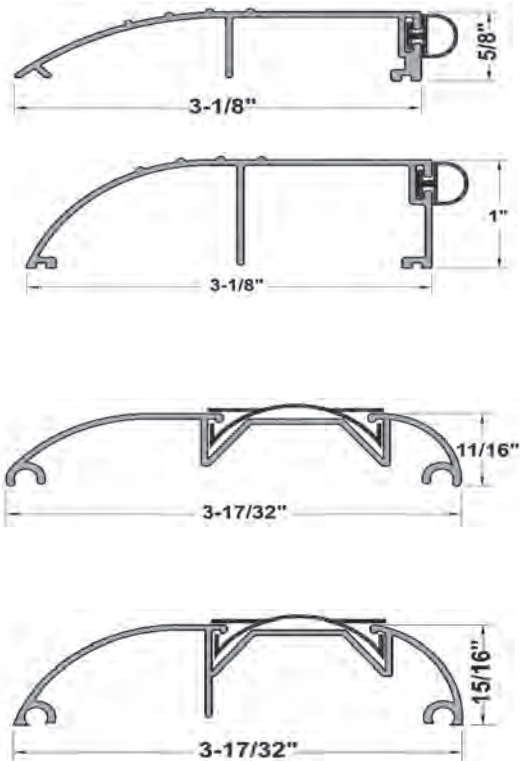

THRESHOLDS



HANDICAP THRESHOLDS

ADA APPROVED

Special Order Options

Specific lengths

Jamb notches

Screw hole punched (for Tapcons)

SADDLE SERIES

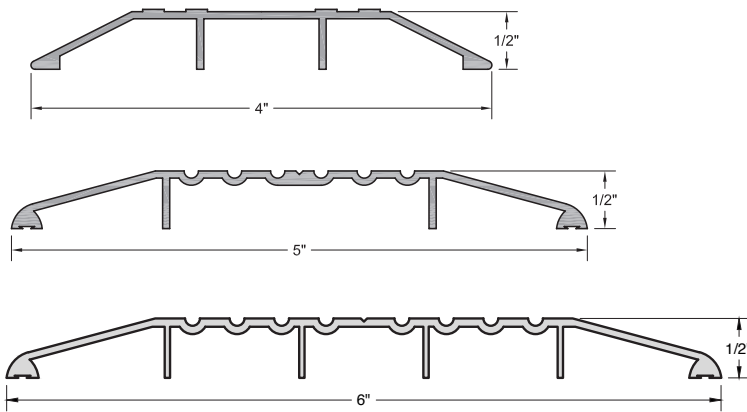

TILE BACK SERIES

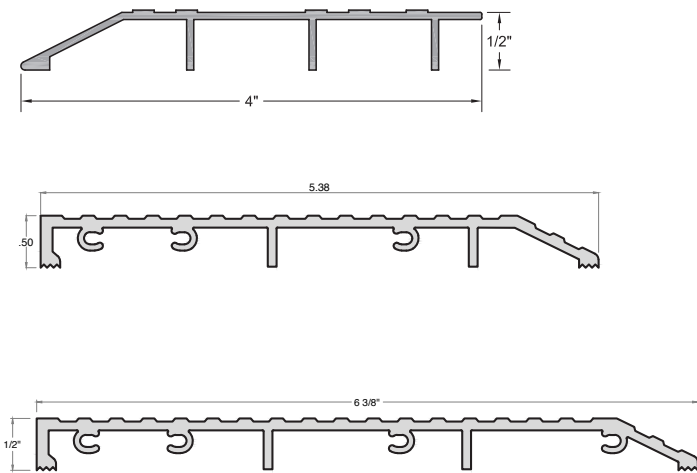

OUTSWING SERIES

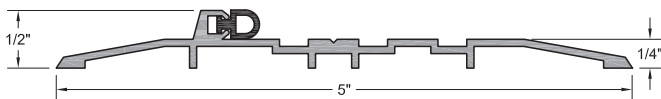

SKU	DESCRIPTION	FINISH	CASE PK
ISHC43612	36-1/2"x4" Handicap Inswing Aluminum Threshold	Mill	10 / 30
ISHC36	36"x5" Handicap Inswing Aluminum Threshold	Mill	10 / 30
ISHC3612	36-1/2"x5" Handicap Inswing Aluminum Threshold	Mill	10 / 30
ISHC73	73"x5" Handicap Inswing Aluminum Threshold	Mill	10 / 30

SKU	DESCRIPTION	FINISH	CASE PK
ISTB36	36"x4" Tile Back Inswing Aluminum Threshold	Mill	10 / 30
ISTB36316	36-3/16"x4" Tile Back Inswing Aluminum Threshold	Mill	10 / 30
ISTB45836	36"x4-5/8" Tile Back Inswing Aluminum Threshold	Mill	10 / 30
ISTB73	73"x4" Tile Back Inswing Aluminum Threshold	Mill	10 / 30
ISTB573	73"x5" Tile Back Inswing Aluminum Threshold	Mill	10 / 30
ISTB673	73"x6" Tile Back Inswing Aluminum Threshold	Mill	10 / 30

SKU	DESCRIPTION	FINISH	CASE PK
OSHC3612	36-1/2"x5" Handicap Outswing Aluminum Threshold	Mill	10 / 30
OSHC36316	36-3/16"x5" Handicap Outswing Aluminum Threshold	Mill	10 / 30
OSHC73	73"x5" Handicap Outswing Aluminum Threshold	Mill	10 / 30

THRESHOLDS

QOSH SERIES

Mill or Bronze Finish
Composite Substrate

Special Order Options

Specific lengths
Jamb notches
Screw hole punched (for Tapcons)

OUTSWING SILLS HAVE 2 7/16" DEPTH FLUSH NOTCH

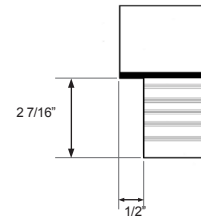

SKU	DESCRIPTION	FINISH	CASE PK
QOSH231516FN	23-15/16" Outswing Aluminum Threshold Flush Notched	Mill w/ Bronze Q-Ion	10 / 30
QOSH271516FN	27-15/16" Outswing Aluminum Threshold Flush Notched	Mill w/ Bronze Q-Ion	10 / 30
QOSH291516FN	29-15/16" Outswing Aluminum Threshold Flush Notched	Mill w/ Bronze Q-Ion	10 / 30
QOSH311516FN	31-15/16" Outswing Aluminum Threshold Flush Notched	Mill w/ Bronze Q-Ion	10 / 30
QOSH331516FN	33-15/16" Outswing Aluminum Threshold Flush Notched	Mill w/ Bronze Q-Ion	10 / 30
QOSH351516FN	35-15/16" Outswing Aluminum Threshold Flush Notched	Mill w/ Bronze Q-Ion	10 / 30
QOSH48716FN	48-7/16" Outswing Aluminum Threshold Flush Notched	Mill w/ Bronze Q-Ion	10 / 30
QOSH60716FN	60-7/16" Outswing Aluminum Threshold Flush Notched	Mill w/ Bronze Q-Ion	10 / 30
QOSH64716FN	64-7/16" Outswing Aluminum Threshold Flush Notched	Mill w/ Bronze Q-Ion	10 / 30
QOSH68716FN	68-7/16" Outswing Aluminum Threshold Flush Notched	Mill w/ Bronze Q-Ion	10 / 30
QOSH72716FN	72-7/16" Outswing Aluminum Threshold Flush Notched	Mill w/ Bronze Q-Ion	10 / 30
QOSH73116FN	73-1/16" Outswing Aluminum Threshold Flush Notched	Mill w/ Bronze Q-Ion	10 / 30
QOSHB36316FN	36-3/16" Outswing Aluminum Threshold Flush Notched	Bronze w/ Bronze Q-Ion	10 / 30
QOSHB73116FN	73-1/16" Outswing Aluminum Threshold Flush Notched	Bronze w/ Bronze Q-Ion	10 / 30

QOSH

1 1/4" high QLON Outswing threshold for use with 4 9/16" jamba

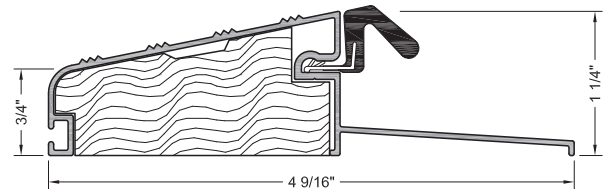

THRESHOLDS

QOSH THRESHOLD EXTENDERS

Mill or Bronze Finish

Special Order Options
Specific lengths

SKU	DESCRIPTION	FINISH	CASE PK
EXTQOSH136	36" Extender- Converts QOS Thresholds to 5-1/4" Width	Mill	10 / 30
EXTQOSH173	73" Extender- Converts QOS Thresholds to 5-1/4" Width	Mill	10 / 30
EXTQOSH236	36" Extender- Converts QOS Thresholds to 6-9/16" Width	Mill	10 / 30
EXTQOSH273	73" Extender- Converts QOS Thresholds to 6-9/16" Width	Mill	10 / 30
EXTQOSHB173	73" Extender- Converts QOS Thresholds to 5-1/4" Width	Bronze	10 / 30
EXTQOSHB273	73" Extender- Converts QOS Thresholds to 6-9/16" Width	Bronze	10 / 30

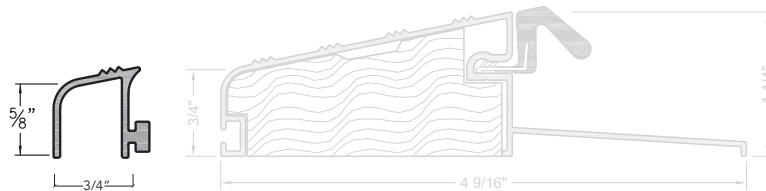

QOSH + EXTQOSH1

This extends the QOSH series threshold to 5 1/4"

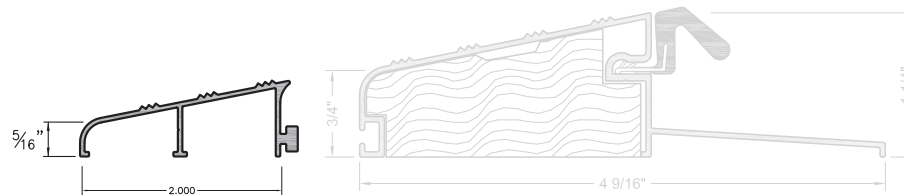

QOSH + EXTQOSH2

This extends the QOSH series threshold to 6 9/16"

THRESHOLDS

QOSR SERIES

Mill or Bronze Finish
Composite substrate

Special Order Options

Specific lengths
Jamb notches
Screw hole punched (for Tapcons)

OUTSWING SILLS HAVE 2 7/16" DEPTH FLUSH NOTCH

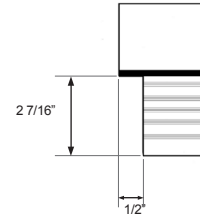

SKU	DESCRIPTION	FINISH	CASE PK
QOSR291516FN	29-15/16" Reverse Outswing Aluminum Threshold Flush Notched	Mill w/ Bronze Q-Ion	10 / 30
QOSR311516FN	31-15/16" Reverse Outswing Aluminum Threshold Flush Notched	Mill w/ Bronze Q-Ion	10 / 30
QOSR231516FN	23-15/16" Reverse Outswing Aluminum Threshold Flush Notched	Mill w/ Bronze Q-Ion	10 / 30
QOSR351516FN	35-15/16" Reverse Outswing Aluminum Threshold Flush Notched	Mill w/ Bronze Q-Ion	10 / 30
QOSR36316FN	36-3/16" Bottom Reverse Outswing Aluminum Threshold Flush Notched	Mill w/ Bronze Q-Ion	10 / 30
QOSR60716FN	60-7/16" Bottom Reverse Outswing Aluminum Threshold Flush Notched	Mill w/ Bronze Q-Ion	10 / 30
QOSR64716FN	64-7/16" Bottom Reverse Outswing Aluminum Threshold Flush Notched	Mill w/ Bronze Q-Ion	10 / 30
QOSR72716FN	72-7/16" Reverse Outswing Aluminum Threshold Flush Notched	Mill w/ Bronze Q-Ion	10 / 30
QOSR73316NN	73-3/16" Bottom Reverse Outswing Aluminum Threshold No Notch	Mill w/ Bronze Q-Ion	10 / 30
QOSR7278BFN	72-7/8" Reverse Outswing Aluminum Threshold Flush Notched	Bronze w/ Bronze Q-Ion	10 / 30

QOSR

1 3/4" high Outswing threshold for use with 4 9/16" jambs. This threshold eliminates HVHZ water infiltration issues and works well with marble flooring.

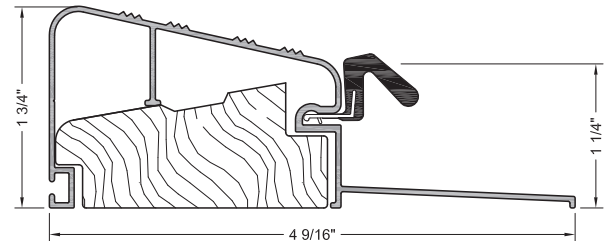

THRESHOLDS

QOSR THRESHOLD EXTENDERS

Mill or Bronze Finish

Special Order Options
Specific lengths

SKU	DESCRIPTION	FINISH	CASE PK
EXTQOSR136	36" Extender- Converts QOSR Thresholds to 5-1/4" Width	Mill	10 / 30
EXTQOSR174	74" Extender- Converts QOSR Thresholds to 5-1/4" Width	Mill	10 / 30
EXTQOSR236	36" Extender- Converts QOSR Thresholds to 6-9/16" Width	Mill	10 / 30
EXTQOSR273	73" Extender- Converts QOSR Thresholds to 6-9/16" Width	Mill	10 / 30
EXTQOSR173B	73" x 5 1/4" Extender- Converts QOSR \Thresholds	Bronze	10 / 30

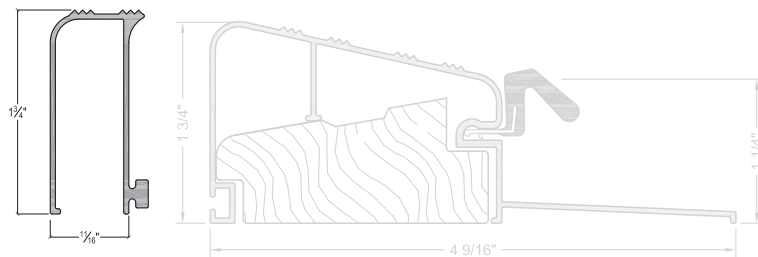

QOSR + EXTQOSR1

This extends the QOSR series threshold to 5 1/4"

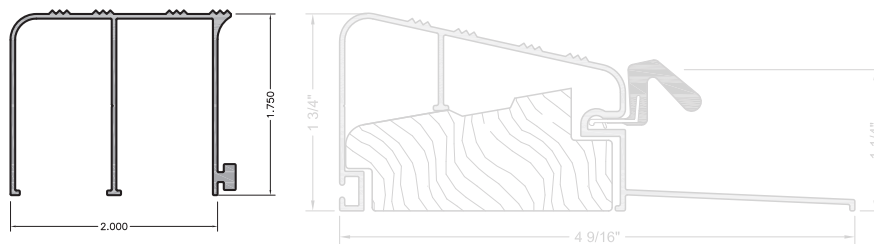

QOSR + EXTQOSR2

This extends the QOSR series threshold to 6 9/16"

THRESHOLDS ALUMINUM

ISCS SERIES (adjusts from 1 1/4" up to 1 1/2" high)

SKU	DESCRIPTION	FINISH	CASE PK
ISCS12	12" Covered Seal Inswing	Mill	10 / 30
ISCS14	14" Covered Seal Inswing	Mill	10 / 30
ISCS231516	23-15/16" Covered Seal Inswing	Mill	10 / 30
ISCS291516	29-15/16" Covered Seal Inswing	Mill	10 / 30
ISCS311516	31-15/16" Covered Seal Inswing	Mill	10 / 30
ISCS32316	32-3/16" Covered Seal Inswing	Mill	10 / 30
ISCS331516	33-15/16" Covered Seal Inswing	Mill	10 / 30
ISCS351516	35-15/16" Covered Seal Inswing	Mill	10 / 30
ISCS351516B	35-15/16" Covered Seal Inswing	Bronze	10 / 30
ISCS36316	36-3/16" Covered Seal Inswing	Mill	10 / 30
ISCS48716	48-7/16" Covered Seal Inswing	Mill	10 / 30
ISCS56716	56-7/16" Covered Seal Inswing	Mill	10 / 30
ISCS60716	60-7/16" Covered Seal Inswing	Mill	10 / 30
ISCS64716	64-7/16" Covered Seal Inswing	Mill	10 / 30
ISCS68716	68-7/16" Covered Seal Inswing	Mill	10 / 30
ISCS72716	72-7/16" Covered Seal Inswing	Mill	10 / 30
ISCS72716B	72-7/16" Covered Seal Inswing	Bronze	10 / 30
ISCS73116	73-1/16 Covered Seal Inswing	Mill	10 / 30
ISCS73116B	73-1/16 Covered Seal Inswing	Bronze	10 / 30

Mill or Bronze Finish
 Composite substrate
 Comes with screw hole plugs

Special Order Options

Specific lengths
 Jamb notches
 Screw hole punched (for Tapcons)

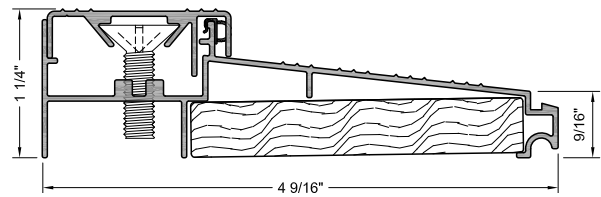

ISCS

Inswing Covered Seal adjustable threshold for use with 4 9/16" jamba.

ISW SERIES (adjusts from 1 1/4" up to 1 1/2" high)

SKU	DESCRIPTION	FINISH	CASE PK
ISW36316	36 3/16" Inswing Adjustable	Mill	10 / 30
ISW73	73" Inswing Adjustable	Mill	10 / 30
ISW73116	73 1/16" Inswing Adjustable	Mill	10 / 30

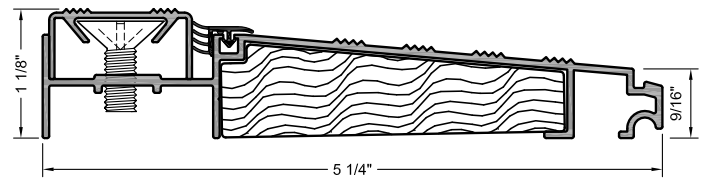

THRESHOLDS

ISCS/ISW THRESHOLD EXTENDERS

SKU	DESCRIPTION	FINISH	CASE PK
EXT173	73" Extender- Converts ISCS Thresholds to 5-1/4" Width	Mill	10 / 30
EXT173B	73" Extender- Converts ISCS Thresholds to 5-1/4" Width	Bronze	10 / 30
EXT273	73" Extender- Converts ISCS Thresholds to 6-9/16" Width	Mill	10 / 30
EXT273B	73" Extender- Converts ISCS Thresholds to 6-9/16" Width	Bronze	10 / 30

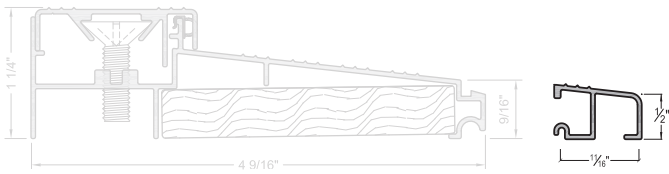

ISCS + EXT1

This extends the ISCS series threshold to 5 1/4

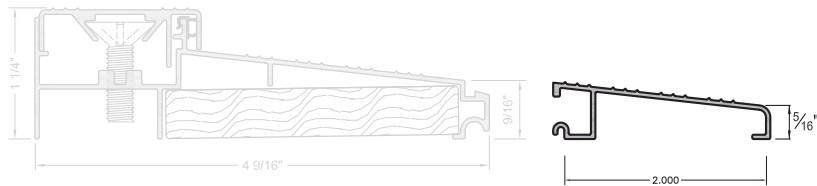

ISCS + EXT2

This extends the ISCS series threshold to 6 9/16" jambs

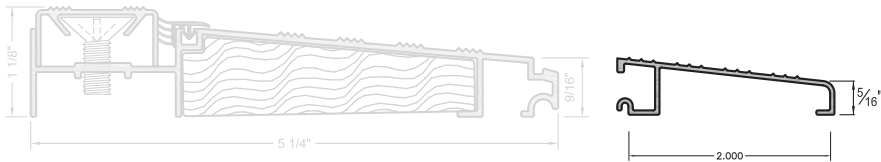

ISW + EXT2

This extends the ISCS series threshold to 7 1/4" jambs

ADDITIONAL ISCS SCREW HOLE PLUGS



SKU	DESCRIPTION	FINISH	CASE PK
ISHPS	PLASTIC SCREW HOLE PLUGS for INSWING THRESHOLDS	MILL	50
ISHPB	PLASTIC SCREW HOLE PLUGS for INSWING THRESHOLDS	BRONZE	50

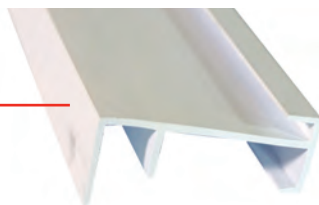

ISCS SIDELIGHT BOOT

SKU	DESCRIPTION	FINISH	CASE PK
ISSLBW12	11-15/16" Inswing Sidelite Boot	White	10 / 30
ISSLBW36	35-15/16" Inswing Sidelite Boot	White	10 / 30

VENTILATING INSERTS



VENTILATING DOORGLASS

This product by DLP Industries is an operational window/insert combo.

SPECIAL NOTE: Windsert Inserts require unique door cut out sizes and will use different installation methods than standard door lights. Consult BHI for training.



Configurations for 6/8 Doors

X XO OX OXO XX XXXX



1/2 LIGHT



1/2 LIGHT
2 PANEL



3/4 LIGHT
1 PANEL
SPECIAL ORDER



FULL LIGHT

Configurations for 8/0 Doors (Special order)

X



1/2 LIGHT



1/2 LIGHT
2 PANEL



FULL LIGHT

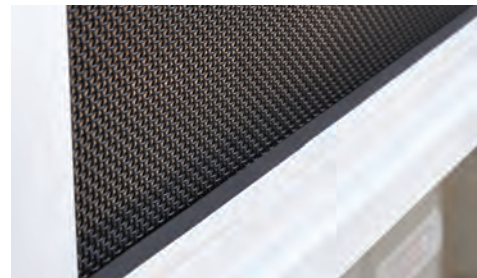

OPTIONAL SECURITY SCREEN

Offers insect control, and hurricane protection

- Premium grade High Tensile 304 Stainless Security mesh
- Impact Resistant
- Allows ventilation without compromising security
- Windsert security screen is available for all door sizes

VENTILATING INSERTS

Not actual colors. Representation only. For actual samples of glass, please contact your sales representative.

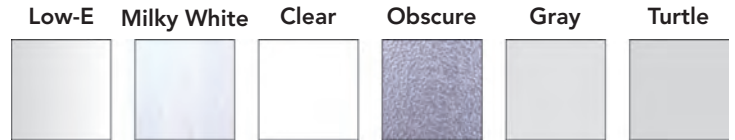

IMPACT WINDSERT DOORGLASS 1/2 LIGHT

(other glass types not shown in specific sizes available special order)

SKU	GLASS SIZE for 6/8 Doors	DESCRIPTION	GLASS TYPE	CASE PK	FOR DOOR SIZE
WI1436MW	14 x 36	Operating Window	Milky White	1	2/0 & 2/4
WI1436CL	14 x 36	Operating Window	Clear	1	2/0 & 2/4
WI1436OBS	14 x 36	Operating Window	Obscure	1	2/0 & 2/4
WI1836LE	18 x 36	Operating Window	Low-E	1	2/6
WI1836MW	18 x 36	Operating Window	Milky White	1	2/6
WI1836CL	18 x 36	Operating Window	Clear	1	2/6
WI1836OBS	18 x 36	Operating Window	Obscure	1	2/6
WI2036LE	20 x 36	Operating Window	Low-E	1	2/8
WI2036MW	20 x 36	Operating Window	Milky White	1	2/8
WI2036CL	20 x 36	Operating Window	Clear	1	2/8
WI2036OBS	20 x 36	Operating Window	Obscure	1	2/8
WI2236LE	22 x 36	Operating Window	Low-E	1	2/10 & 3/0
WI2236MW	22 x 36	Operating Window	Milky White	1	2/10 & 3/0
WI2236CL	22 x 36	Operating Window	Clear	1	2/10 & 3/0
WI2236OBS	22 x 36	Operating Window	Obscure	1	2/10 & 3/0
WI2236GRAY	22 x 36	Operating Window	Gray	1	2/10 & 3/0

IMPACT WINDSERT DOORGLASS FULL LIGHT

(other glass types not shown in specific sizes available special order)

SKU	GLASS SIZE for 6/8 Doors	DESCRIPTION	GLASS TYPE	CASE PK	FOR DOOR SIZE
WI1464MW	14 x 64	Operating Window	Milky White	1	2/0 & 2/4
WI1464CL	14 x 64	Operating Window	Clear	1	2/0 & 2/4
WI1464OBS	14 x 64	Operating Window	Obscure	1	2/0 & 2/4
WI1864LE	18 x 64	Operating Window	Low-E	1	2/6
WI2064LE	20 x 64	Operating Window	Low-E	1	2/8
WI2064MW	20 x 64	Operating Window	Milky White	1	2/8
WI2064CL	20 x 64	Operating Window	Clear	1	2/8
WI2264LE	22 x 64	Operating Window	Low-E	1	2/10 & 3/0
WI2264MW	22 x 64	Operating Window	Milky White	1	2/10 & 3/0
WI2264CL	22 x 64	Operating Window	Clear	1	2/10 & 3/0
WI2264OBS	22 x 64	Operating Window	Obscure	1	2/10 & 3/0

All size Windserts available by special order in NON-IMPACT glass with the exception of turtle glass.

HINGES

BHI Hinges

One of the sayings we at BHI have in the door pre-hanging business is, if you have doors, beautiful door glass, all the door frames, thresholds, weatherstripping, locking hardware you need with machines and staff to hang doors- BUT YOU DON'T HAVE ANY HINGES- WELL, YOU ARE S.O.H. YOU CANNOT HANG DOORS.

Truth simply spoken.

Often over the years hinges have been hard to come by. They are either in large supply and too cheap or too expensive and not available. Most companies have to use multiple sources to keep up with supply and demand for truly decent hinges, as well as, to get ALL the different kinds of hinges or colors they may need for different jobs.

This is where BHI can help you. BHI offers a wide variety of the TOP quality hinges at a very fair price that you may need for your door shop. And, when we tell you we have hinges to hang doors- we are not shy when it comes to inventory.

BHI offers the best-in-class hinges in stainless steel, and most popular U.S. colors.

Hinges for the door hanger, for exterior and interior doors.

We don't forget how important proper screws are!

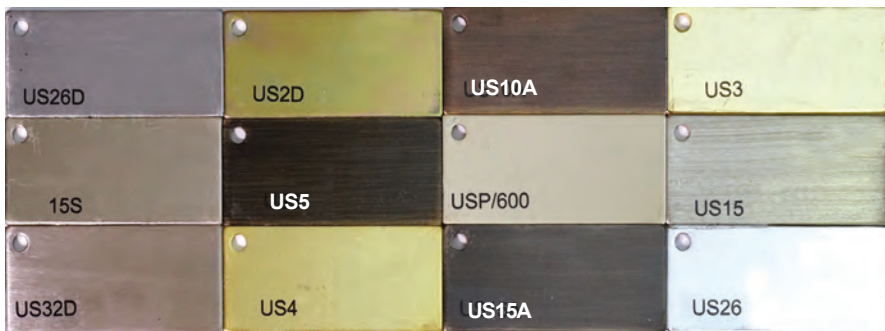
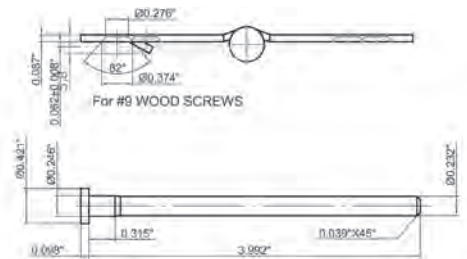
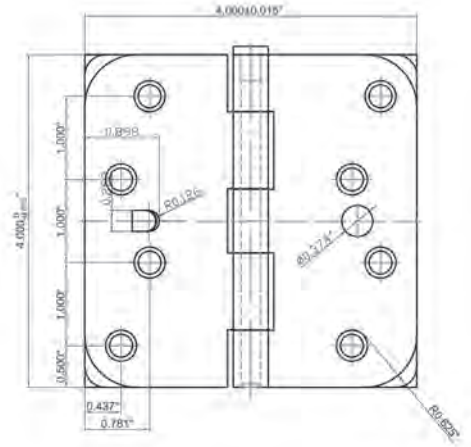

Color chart for representation only.

HINGES

RESIDENTIAL HINGES

See color chart page 26.

INTERIOR DOOR HINGES – 3-1/2" x 3-1/2" RADIUS



SKU	SIZE	DESCRIPTION	FINISH	CASE PK
3122D58	3-1/2"x3-1/2"	Interior Hinge Radius 5/8" x 5/8"	Zinc	100 / 1000
312P58	3-1/2"x3-1/2"	Interior Hinge Radius 5/8" x 5/8"	Primed	100 / 1000
312US358	3-1/2"x3-1/2"	Interior Hinge Radius 5/8" x 5/8"	Bright Brass	100 / 1000
312558	3-1/2"x3-1/2"	Interior Hinge Radius 5/8" x 5/8"	Antique Brass	100 / 1000
31226D58	3-1/2"x3-1/2"	Interior Hinge Radius 5/8" x 5/8"	Satin Chrome	100 / 1000
31215A58	3-1/2"x3-1/2"	Interior Hinge Radius 5/8" x 5/8"	Antique Nickel	100 / 1000
3121558	3-1/2"x3-1/2"	Interior Hinge Radius 5/8" x 5/8"	Satin Nickel	100 / 1000
31210P58	3-1/2"x3-1/2"	Interior Hinge Radius 5/8" x 5/8"	Satin Bronze	100 / 1000
3122658	3-1/2"x3-1/2"	Interior Hinge Radius 5/8" x 5/8"	Bright Chrome	100 / 1000
3123LB	3-1/2"x3-1/2"	Interior Hinge Radius 5/8" x 5/8"	Brushed Brass	100 / 1000



INTERIOR SPRING HINGES – 3-1/2" x 3-1/2" RADIUS

SKU	SIZE	DESCRIPTION	FINISH	CASE PK
SP31215S558	3-1/2"x3-1/2"	Interior Spring Hinge Radius 5/8" x 5/8"	Satin Nickel	100 / 1000

INTERIOR/EXTERIOR HINGE SCREWS



SKU	SIZE	DESCRIPTION	FINISH	CASE PK
SCREWSUS10B	3/4" x #9	Wood hinge screws	Oil Rubbed Bronze	800 / 4000
SCREWSUS15	3/4" x #9	Wood hinge screws	Satin Nickel	800 / 4000
SCREWSUS2D	3/4" x #9	Wood hinge screws	Zinc	800 / 4000
SCREWSUSPP	3/4" x #9	Wood hinge screws	Primed	800 / 4000
SCREWSUS32D	3/4" x #9	Wood hinge screws	Stainless Steel	800 / 4000
SCREWSUS26D	3/4" x #9	Wood hinge screws	Dull Chrome	800 / 4000

Other finishes available: Antique Nickel, Satin Chrome, Bright Brass, and Antique Brass

HINGES

RESIDENTIAL HINGES

See color chart page 26.

EXTERIOR DOOR HINGES 4"x4" RADIUS X RADIUS SECURITY

SKU	SIZE	DESCRIPTION	FINISH	CASE PK
42D58STUD	4"x4"	Exterior Hinge w/ Safety Stud Radius 5/8" x 5/8"	Zinc	100 / 1000
4P58STUD	4"x4"	Exterior Hinge w/ Safety Stud Radius 5/8" x 5/8"	Primed	100 / 1000
426D58STUD	4"x4"	Exterior Hinge w/ Safety Stud Radius 5/8" x 5/8"	Satin Chrome	100 / 1000
41558STUD	4"x4"	Exterior Hinge w/ Safety Stud Radius 5/8" x 5/8"	Satin Nickel	100 / 1000
410B58STUD	4"x4"	Exterior Hinge w/ Safety Stud Radius 5/8" x 5/8"	Satin Bronze	100 / 1000
432D58STUD	4"x4"	Exterior Hinge w/ Safety Stud Radius 5/8" x 5/8"	Stainless Steel	100 / 1000
4US358STUD	4"x4"	Exterior Hinge w/ Safety Stud Radius 5/8" x 5/8"	Bright Brass	100 / 1000
415A58STUD	4"x4"	Exterior Hinge w/ Safety Stud Radius 5/8" x 5/8"	Antique Nickel	100 / 1000
4155S58STUD	4"x4"	Exterior Hinge w/ Safety Stud Radius 5/8" x 5/8"	Smooth Satin Nickel	100 / 1000
4558NRP	4"x4"	Exterior Hinge w/ Safety Stud Radius 5/8" x 5/8" Non-Removable Pin	Antique Brass	100 / 1000



EXTERIOR DOOR HINGES 4"x4" RADIUS X SQUARE SECURITY

SKU	SIZE	DESCRIPTION	FINISH	CASE PK
42D58SQSTUDL	4"x4"	Exterior Hinge w/ Safety Stud Left Handed 5/8" RADxSQR	Zinc	100 / 1000
42D58SQSTUDR	4"x4"	Exterior Hinge w/ Safety Stud Right Handed 5/8" RADxSQR	Zinc	100 / 1000
41558SQSTUDL	4"x4"	Exterior Hinge w/ Safety Stud Left Handed 5/8" RADxSQR	Satin Nickel	100 / 1000
41558SQSTUDR	4"x4"	Exterior Hinge w/ Safety Stud Right Handed 5/8" RADxSQR	Satin Nickel	100 / 1000
410B58SQSTUDL	4"x4"	Exterior Hinge w/ Safety Stud Left Handed 5/8" RADxSQR	Satin Bronze	100 / 1000
410B58SQSTUDR	4"x4"	Exterior Hinge w/ Safety Stud Right Handed 5/8" RADxSQR	Satin Bronze	100 / 1000
432D58SQSTUDL	4"x4"	Exterior Hinge w/ Safety Stud Left Handed 5/8" RADxSQR	Stainless Steel	100 / 1000
432D58SQSTUDR	4"x4"	Exterior Hinge w/ Safety Stud Right Handed 5/8" RADxSQR	Stainless Steel	100 / 1000
4US358SQSTUDR	4"x4"	Exterior Hinge w/ Safety Stud- Right Hand/ Reversible 5/8" RADxSQR	Bright Brass	100 / 1000
4US358SQSTUDL	4"x4"	Exterior Hinge w/ Safety Stud- Right Hand/ Reversible 5/8" RADxSQR	Bright Brass	100 / 1000
CAS44L26DNRP	4"x4"	Exterior Hinge w/ Safety Stud Left Handed 5/8" RADxSQR Non-Removable Pin	Dull Chrome	100 / 1000
CAS44R26DNRP	4"x4"	Exterior Hinge w/ Safety Stud Right Handed 5/8" RADxSQR Non-Removable Pin	Dull Chrome	100 / 1000



LEFT HAND



RIGHT HAND

For additional screws see page 27.

HINGES

See color chart page 26.

RESIDENTIAL HINGES



EXTERIOR DOOR SPRING HINGES 4"x4" RADIUS X RADIUS

SKU	SIZE	DESCRIPTION	FINISH	CASE PK
SP42D58	4"x4"	Exterior Spring Hinge 5/8" RADxRAD	Zinc	100 / 1000
SP4P58	4"x4"	Exterior Spring Hinge 5/8" RADxRAD	Primed	100 / 1000
SP410B58	4"x4"	Exterior Spring Hinge 5/8" RADxRAD	Bronze	100 / 1000
SP415S58	4"x4"	Exterior Spring Hinge 5/8" RADxRAD	Satin Nickel	100 / 1000



EXTERIOR DOOR SPRING HINGES 4"x4" RADIUS X SQUARE

SKU	SIZE	DESCRIPTION	FINISH	CASE PK
SP410B5SQLEFT	4"x4"	4"x4"x5/8" RADxSQR Residential Exterior Spring Hinge- Left Handed	Oil Rubbed Bronze	100 / 1000
SP410B58SQRRIGHT	4"x4"	4"x4"x5/8" RADxSQR Residential Exterior Spring Hinge- Right Handed	Oil Rubbed Bronze	100 / 1000
SP415S58SQL	4"x4"	4"x4"x5/8" RADxSQR Residential Exterior Spring Hinge- Left Handed	Smooth Satin Nickel	100 / 1000
SP415S58SQR	4"x4"	4"x4"x5/8" RADxSQR Residential Exterior Spring Hinge- Right Handed	Smooth Satin Nickel	100 / 1000
SP42D58XSQLEFT	4"x4"	4"x4"x5/8" RADxSQR Residential Exterior Spring Hinge- Left Handed	Zinc	100 / 1000
SP42D58XSQRIGHT	4"x4"	4"x4"x5/8" RADxSQR Residential Exterior Spring Hinge- Right Handed	Zinc	100 / 1000
SP4P58XSQRIGHT	4"x4"	4"x4"x5/8" RADxSQR Residential Exterior Spring Hinge- Right Handed	Primed	100 / 1000

EXTERIOR DOOR BALL BEARING HINGES 4"x4" SQUARE X RADIUS



LEFT HAND



RIGHT HAND

SKU	SIZE	DESCRIPTION	FINISH	CASE PK
BB432DSQR58STUDL	4"x4"	Ball Bearing Exterior Hinge w/ Safety Stud- Left Handed 5/8" RADxSQR	Stainless Steel	100 / 1000
BB432DSQR58STUDR	4"x4"	Ball Bearing Exterior Hinge w/ Safety Stud- Right Handed 5/8" RADxSQR	Stainless Steel	100 / 1000
BB42D58SQSTUDL	4"x4"	Ball Bearing Exterior Hinge w/ Safety Stud- Left Handed 5/8" RADxSQR	Zinc	100 / 1000
BB42D58SQSTUDR	4"x4"	Ball Bearing Exterior Hinge w/ Safety Stud- Right Handed 5/8" RADxSQR	Zinc	100 / 1000



EXTERIOR DOOR BALL BEARING HINGES 4"x4" RADIUS X RADIUS

SKU	SIZE	DESCRIPTION	FINISH	CASE PK
BB432D58STUD	4"x4"	Exterior Hinge Ball Bearing w/ Safety Stud 5/8" RADxRAD	Satin Bronze	100 / 1000
BB432D58STUD	4"x4"	Exterior Hinge Ball Bearing w/ Safety Stud 5/8" RADxRAD	Stainless Steel	100 / 1000

For additional screws see page 27.

HINGES

COMMERCIAL & RESIDENTIAL

DOUBLE-ACTING
SPRING PIVOT HINGES

#3029 4" through 6" MORTISE

Ansi K81041

* Door Flange is mortised into edge of door

* Jamb flange is surface applied to jamb

* Steel Material

* Non-Template

* Non-Handed

* All wood screws

Do not use on doors with beveled hinge edge



SKU	DESCRIPTION	FINISH	CASE PK
3029-4PC	4" Bommer Double Acting Spring Hinge	Primed	6 / 12
3029-5PC	5" Bommer Double Acting Spring Hinge	Primed	6 / 12
3029-510B	5" Bommer Double Acting Spring Hinge	Oil Rubbed Bronze	6 / 12
3029-526D	5" Bommer Double Acting Spring Hinge	Satin Chrome	6 / 12
3029-6PC	6" Bommer Double Acting Spring Hinge	Primed	6 / 12
3029-6PB	6" Bommer Double Acting Spring Hinge	Bright Brass	6 / 12
3029-6US26D	6" Bommer Double Acting Spring Hinge	Satin Chrome	6 / 12

COMMERCIAL & RESIDENTIAL

DOUBLE-ACTING FLOOR SPRING PIVOTS

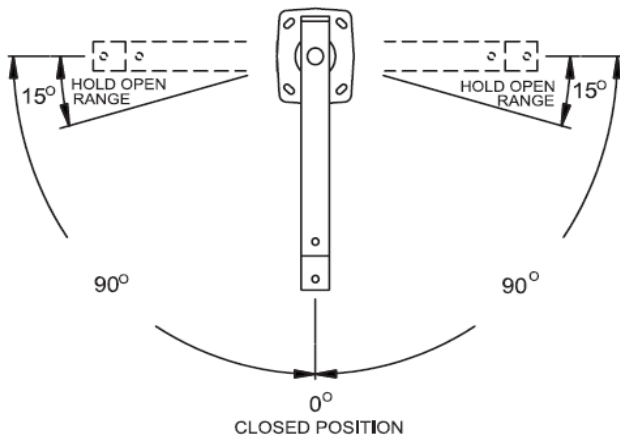

SKU	DESCRIPTION	FINISH	CASE PK
7802US26D	Bommer Light Duty Double Acting Floor Mounted Spring Hinge	Satin Chrome	6 / 12
7812US10B	Bommer Medium Duty Double Acting Floor Mounted Spring Hinge	Oil Rubbed Bronze	6 / 12
7812US15	Bommer Medium Duty Double Acting Floor Mounted Spring Hinge	Satin Nickel	6 / 12
7812US26D	Bommer Medium Duty Double Acting Floor Mounted Spring Hinge	Satin Chrome	6 / 12
7812US3	Bommer Medium Duty Double Acting Floor Mounted Spring Hinge	Bright Brass	6/12

WEATHER SEALS

Weatherstrip



When it comes to keeping the good weather in and the bad weather out, Pro-Lon is the REAL deal. Manufactured in North America. Both Pro-Lon's short reach and long reach weatherstripping types are designed to stand the test of time in harsh environments. Their kerf door seals are designed to fit into jamb kerfs perfectly – not too tight – not too loose.



WEATHER SEALS

WEATHERSTRIP

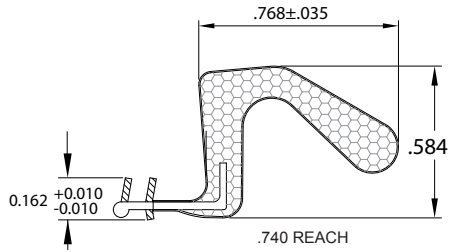
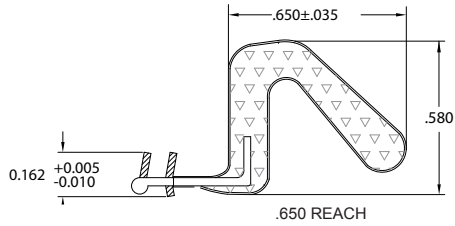

CORNER SEAL



Width: 1.688" (42.9mm) **Reach:** .218" (5.5mm)

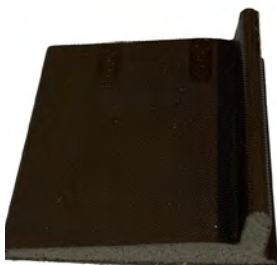

SKU	DESCRIPTION	FINISH	CASE PK
DSFC650K16282WH	82" .650 Reach Pro-Lon Weatherstrip	White	125
DSFC650K16282BZ	82" .650 Reach Pro-Lon Weatherstrip	Bronze	125
DSFC650K16297WH	97" .650 Reach Pro-Lon Weatherstrip	White	125
DSFC650K16297BZ	97" .650 Reach Pro-Lon Weatherstrip	Bronze	125
DSFC740K16285WH	85" .740 Long Reach Pro-Lon Weatherstrip	White	125
DSFC740K16297WH	97" .740 Long Reach Pro-Lon Weatherstrip	White	125
DSFC740K16297BZ	97" .740 Long Reach Pro-Lon Weatherstrip	Bronze	125

SKU	DESCRIPTION	FINISH	CASE PK
CSADH1688WH	2" Corner Seal	White	2000
CSADH1688BRZ	2" Corner Seal	Bronze	2000



SKU	DESCRIPTION	FINISH	CASE PK
SSCORNERPADWH	Simple Solution Corner Pad (2 Pack)	White	50 / 200
SSCORNERPADBR	Simple Solution Corner Pad (2 Pack)	Bronze	50 / 200

WEATHER SEALS



DLP INDUSTRIES

DOOR SEAL PRODUCTS

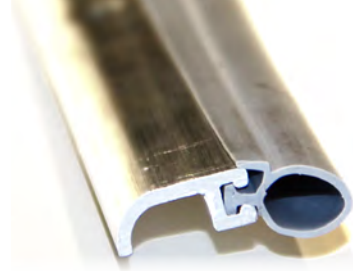

SKU	DESCRIPTION	FINISH	CASE PK
JAMBUP17	17' Aluminum & Vinyl Weatherstrip	Mill/ Grey	100 / 300

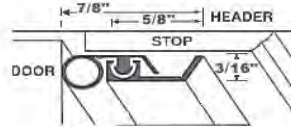
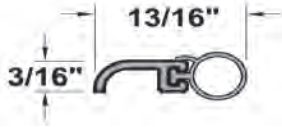

SKU	DESCRIPTION	FINISH	CASE PK
BULKBUG36	36" Bug Sweep (Bulk Pack)	Mill	100 / 300

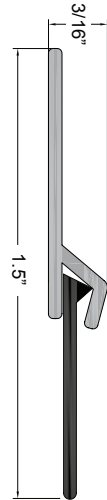

BULKBUG36
CROSS SECTION
HAS 4 SCREW HOLES



SKU	DESCRIPTION	FINISH	CASE PK
DTBR30	36" Top Seal for Outswing Doors	Bronze	50 / 200

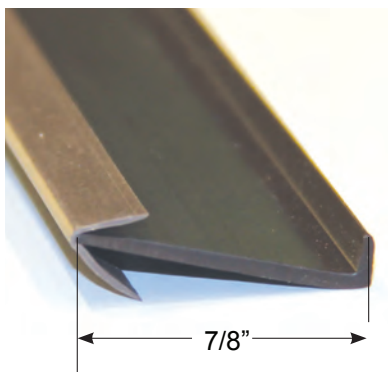

7/8" Top seal application

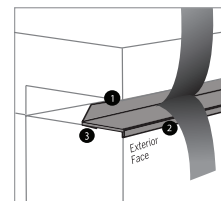
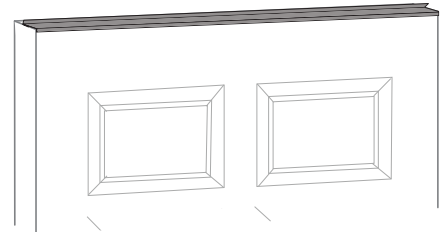

1. Top fin compresses as door closes, creating a seal between the header and the top of the door. The fin creates a barrier that directs water over the edge and down the exterior of the door.

WEATHER SEALS

DOOR SWEEPS

WRAP ADJUSTABLE DOOR SWEEP

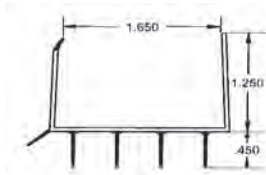
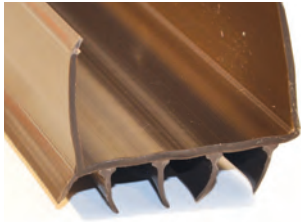

SKU	DESCRIPTION	FINISH	CASE PK
WTV02380WH037	37" Length Wrap Door Sweep	White	24
WTV02380CB037	37" Length Wrap Door Sweep	Bronze	24

SCREW/STAPLE DOOR SWEEP

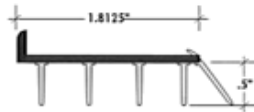
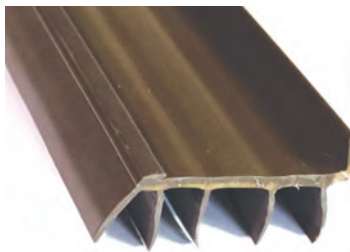

SKU	DESCRIPTION	FINISH	CASE PK
WTV03871CB037	37" Length Screw/ Staple Door Sweep	Bronze	50
WTV03871CB048	48" Length Screw/ Staple Door Sweep	Bronze	50

DOOR SWEEP SCREWS



SKU	DESCRIPTION	FINISH	CASE PK
110805W	8x1/2" Self-Tap Sheet Metal Screw (5pk)	White	96 Packs
110805B	8x1/2" Self-Tap Sheet Metal Screw (5pk)	Bronze	96 Packs

PRESSURE FIT DOOR SWEEP

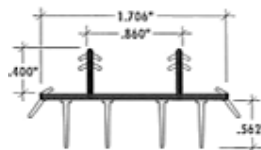
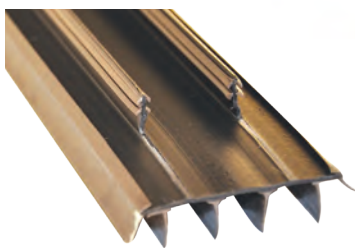

SKU	DESCRIPTION	FINISH	CASE PK
WTV03122DK03575	35-3/4" Length Pressure Fit Door Sweep	Bronze	100
WTV01996CB030X4	29-13/16" Length Pressure Fit Door Sweep	Bronze	50
WTV01996CB032X4	31-13/16" Length Pressure Fit Door Sweep	Bronze	50
WTV01996CB036X4	35-13/16" Length Pressure Fit Door Sweep	Bronze	50

MULTI-POINT SECURITY HARDWARE

TRILENNIUM™ Multi-Point
Locking System

Security Hardware

Security. Strength. Reliability. Performance.

Unmatched security doesn't have to mean compromised style. Trilennium offers a growing portfolio of attractive handset designs that features one solid unit with three latches based on the strength of patented I-Beam construction for reliable, proven strength and performance. Operating as one unit, all three latches engage when the door is closed. With one movement of the thumbturn or key activates all three deadbolts. Each latch is a deadbolt and adds increased protection for any home.

- Patented Strike Rollers and latches draw the door panel into perfect alignment with the jamb for a tight seal with no deflection
- A single downward turn of the interior handle releases all three deadbolts making it panic-proof
- Keying available; BHI stock trim sets have a Weiser Keyway, also available with Schlage C Keyway or Smart Key
- Manufactured in the USA



ECLIPSE GRIP SET
SHOWN IN
VICTORIAN BRONZE

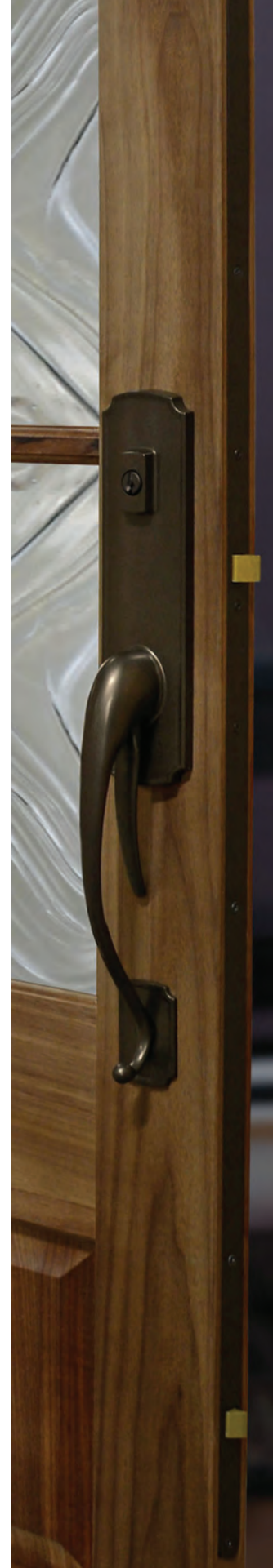

MULTI-POINT SECURITY HARDWARE

SPECIFICATIONS GUIDE

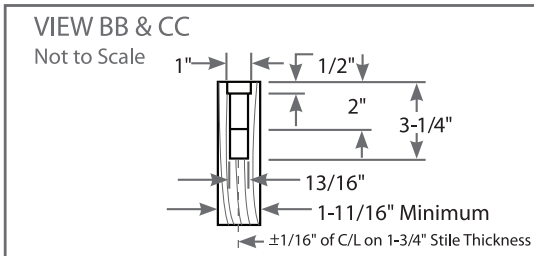
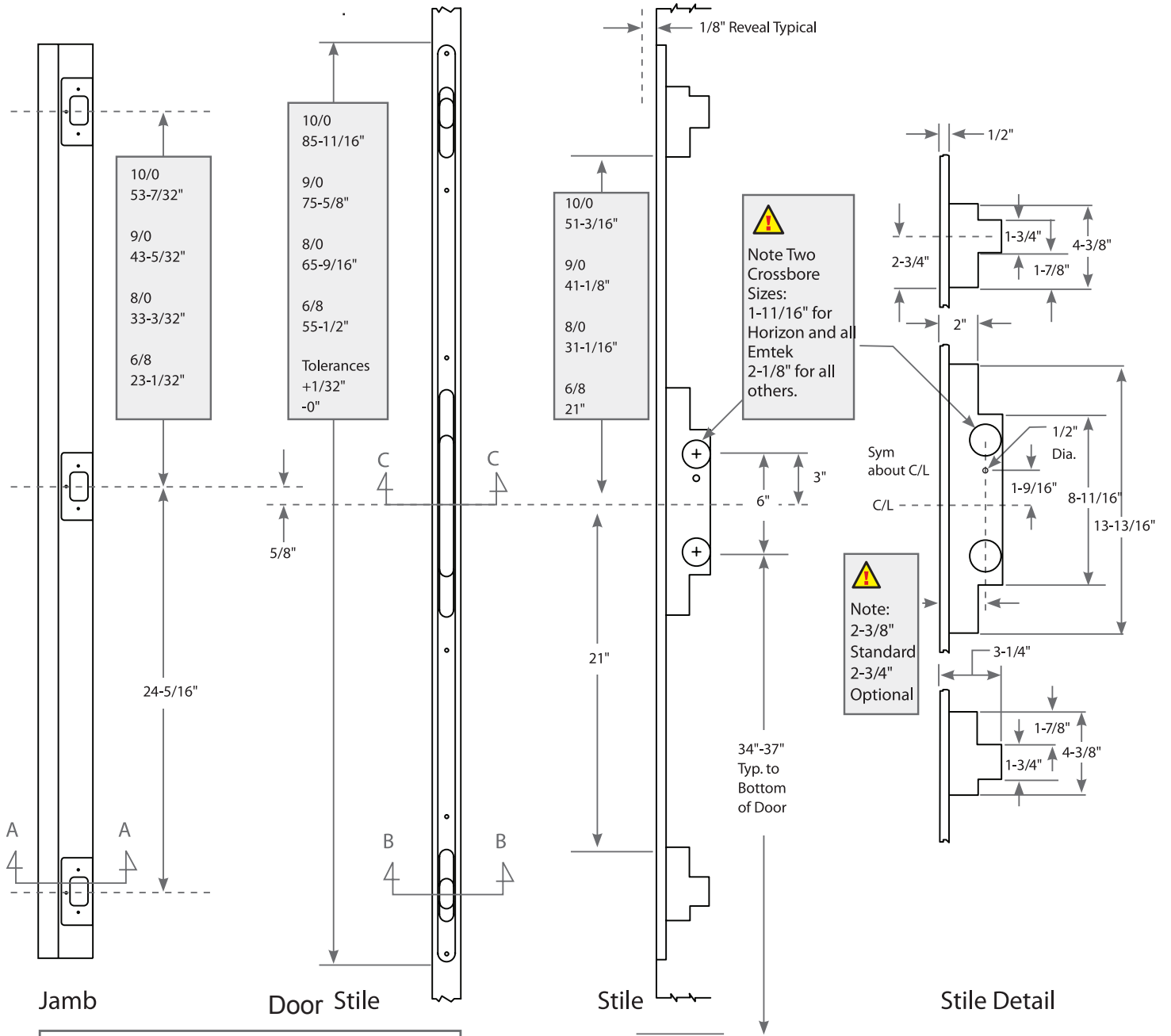

MULTI-POINT SECURITY HARDWARE

MULTI-POINT LOCK MECHANISM

SKU	DESCRIPTION	FINISH	CASE PK
TL3000SS68RISBNP	6/8 & 7/0 Multipoint Lock Mechanism RH	Stainless Steel	1/5
TL3000SS68LISBNP	6/8 & 7/0 Multipoint Lock Mechanism LH	Stainless Steel	1/5
TL3000SS80RISBNP	8/0 Multipoint Lock Mechanism RH	Stainless Steel	1/5
TL3000SS80LISBNP	8/0 Multipoint Lock Mechanism LH	Stainless Steel	1/5



PARTS LIST TO USE WITH MECHANISM

SKU	DESCRIPTION	FINISH	CASE PK
TCSTRKPCK225SS	Outswing US32D (3)Strike Kit w/ Screws	Stainless Steel	3 / 6
TCSTRKPCK175SS	Inswing US32D (3)Strike Kit w/ Screws	Stainless Steel	3 / 6
TCREINFPLATKIT	Reinforcing Roller (3)Strike Plate Kit	Stainless Steel	3 / 6
TCDUSTBOX	Plastic Dust Box	Black	3 / 6
TCCNSTRCTHNDL175	Construction Handle	Aluminum	3 / 6

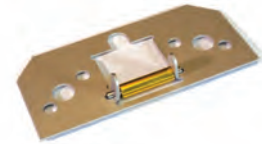

Strike Roller Plate



Construction Handle



Strike Kit



Strike Kit

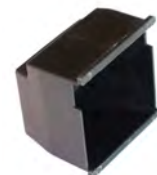

Dust Box

MULTI-POINT SECURITY HARDWARE

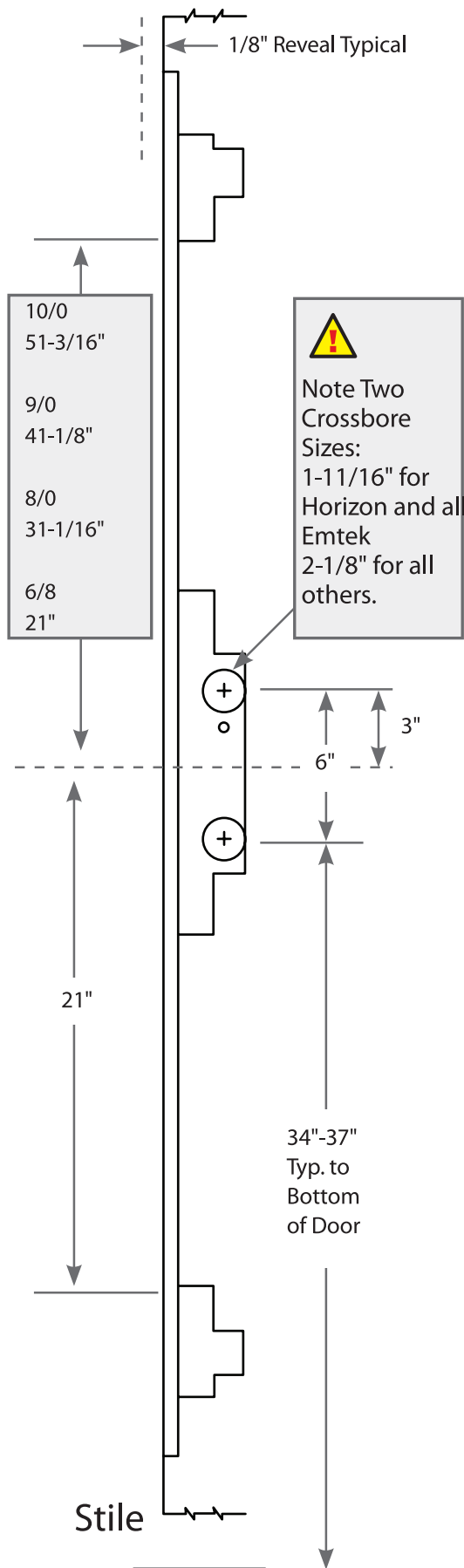

MULTI-POINT SECURITY HARDWARE

MULTI-POINT LOCK TRIMS

SKU	DESCRIPTION	FINISH	CASE PK
ECPGACTSN175RW	Eclipse Active Gripset US15 RHIS/ LHOS	Satin Nickel	3 / 6
ECPGACTSN175LW	Eclipse Active Gripset US15 LHIS/ RHOS	Satin Nickel	3 / 6
ECPGDUMSN175R	Eclipse Dummy Gripset US15 RHIS/ LHOS	Satin Nickel	3 / 6
ECPGDUMSN175L	Eclipse Dummy Gripset US15 LHIS/ RHOS	Satin Nickel	3 / 6
ECPGACTVB175RW	Eclipse Active Gripset US10P RHIS/ LHOS	Victorian Bronze	3 / 6
ECPGACTVB175LW	Eclipse Active Gripset US10P LHIS/ RHOS	Victorian Bronze	3 / 6
ECPGDUMVB175R	Eclipse Dummy Gripset US15 RHIS/ LHOS	Satin Nickel	3 / 6
ECPGDUMVB175L	Eclipse Dummy Gripset US15 LHIS/ RHOS	Satin Nickel	3 / 6



ECLIPSE
SHOWN IN
SATIN NICKEL

SKU	DESCRIPTION	FINISH	CASE PK
ECPLACTSN175NW	Eclipse Active Leverset US15	Satin Nickel	3 / 6
ECPLDUMSN175N	Eclipse Dummy Leverset US15	Satin Nickel	3 / 6
ECPLACTVB175NW	Eclipse Active Leverset US10P	Victorian Bronze	3 / 6
ECPLDUMVB175N	Eclipse Dummy Leverset US10P	Victorian Bronze	3 / 6



ECLIPSE GRIP SET
SHOWN IN
VICTORIAN BRONZE

OPTIONAL KEY CYLINDERS FOR TRIM SETS

SKU	DESCRIPTION	FINISH	CASE PK
TCKEYCYLS175PC	Schlage Keyway for 1-3/4" Door US26D	Satin Chrome	3 / 6
TCKEYCYLS225PC	Schlage Keyway for 2-1/4" Door US26D	Satin Chrome	3 / 6
TC-KEYCYLR-175SN	Smart Key for 1 3/4" Doors US26D	Satin Chrome	3 / 6
TC-KEYBLANK-R	Key Blank	Satin Chrome	3 / 6



Key Cylinder

Keying available; BHI Stock have Weiser Keyway cylinders. Also available with Schlage C Keyway or Smart Key.

MULTI-POINT SECURITY HARDWARE

MULTI-POINT LOCK TRIMS



PINNACLE
SHOWN IN VICTORIAN BRONZE

SKU	DESCRIPTION	FINISH	CASE PK
PINLACTSN175NW	Pinnacle Active Leverset US15	Satin Nickel	3 / 6
PINLDUMSN175N	Pinnacle Dummy Leverset US15	Satin Nickel	3 / 6
PINLACTVB175NW	Pinnacle Active Leverset US10P	Victorian Bronze	3 / 6
PINLDUMVB175N	Pinnacle Dummt Leverset US10P	Victorian Bronze	3 / 6



HORIZON
SHOWN IN SATIN NICKEL

SKU	DESCRIPTION	FINISH	CASE PK
HORLACTVB175NW	Horizon Active Leverset US10P	Victorian Bronze	3 / 6
HORLDUMVB175N	Horizon Dummy Leverset US10P	Victorian Bronze	3 / 6
HORLACTSN175NW	Horizon Active Leverset US15	Satin Nickel	3 / 6
HORLDUMSN175N	Horizon Dummy Leverset US15	Satin Nickel	3 / 6

OPTIONAL KEY CYLINDERS FOR TRIM SETS



Key Cylinder

SKU	DESCRIPTION	FINISH	CASE PK
TCKEYCYLS175PC	Schlage Keyway for 1-3/4" Door US26D	Satin Chrome	3 / 6
TCKEYCYLS225PC	Schlage Keyway for 2-1/4" Door US26D	Satin Chrome	3 / 6
TC-KEYCYLR-175SN	Smart Key for 1 3/4" Doors US26D	Satin Chrome	3 / 6
TC-KEYBLANK-R	Key Blank	Satin Chrome	3 / 6

Keying available; BHI Stock have Weiser Keyway cylinders. Also available with Schlage C Keyway or Smart Key.

MULTI-POINT SECURITY HARDWARE

SKU	DESCRIPTION	FINISH	CASE PK
RECLACTSN175NW	Rectangular Active Leverset US15	Satin Nickel	3 / 6
RECLDUMSN175NW	Rectangular Dummy Leverset US15	Satin Nickel	3 / 6
RECLACTVB175NW	Rectangular Active Leverset US10P	Victorian Bronze	3 / 6
RECLDUMVB175NW	Rectangular Dummy Leverset US10P	Victorian Bronze	3 / 6



RECTANGULAR
SHOWN IN POWDER COAT BLACK

SKU	DESCRIPTION	FINISH	CASE PK
CRVLACTSN175NW	Curved Active Leverset US15	Satin Nickel	3 / 6
CRVLDUMSN175NW	Curved Dummy Leverset US15	Satin Nickel	3 / 6
CRVLACTVB175NW	Curved Active Leverset		3 / 6
CRVLDUMVB175NW	Curved Dummy Leverset		3 / 6



CURVED
SHOWN IN POWDER COAT BLACK

OPTIONAL KEY CYLINDERS FOR TRIM SETS

SKU	DESCRIPTION	FINISH	CASE PK
TCKEYCYLS175PC	Schlage Keyway for 1-3/4" Door US26D	Satin Chrome	3 / 6
TCKEYCYLS225PC	Schlage Keyway for 2-1/4" Door US26D	Satin Chrome	3 / 6
TC-KEYCYLR-175SN	Smart Key for 1 3/4" Doors US26D	Satin Chrome	3 / 6
TC-KEYBLANK-R	Key Blank	Satin Chrome	3 / 6



Key Cylinder

Keying available; BHI Stock have Weiser Keyway cylinders. Also available with Schlage C Keyway or Smart Key.

MULTI-POINT LOCK TRIMS

OPTIONAL SPECIAL ORDER



ARCHED
SHOWN IN MEDIUM BRONZE



MODERN
SHOWN IN BRIGHT CHROME



MODERN
SHOWN IN STAINLESS STEEL



TUSCANY
SHOWN IN FLAT BLACK BRONZE

DOOR LOUVERS

PVC VENTILATING DOOR LOUVERS

These high quality PVC ventilating louvers have a low profile flat frame, install like a door light (interior and exterior frame) and come with screens and screw hole plugs.



FOR 1-3/4" DOOR

Many other standard and custom sizes available by Special Order.

SKU	Size	Description	MIN PK
PVC1212FS134	12x12	PVC EXTERIOR DOOR LOUVER with FG SCREEN	6
PVC2424FS134	24x24	PVC EXTERIOR DOOR LOUVER with FG SCREEN	6
PVC2424FS134	24x24	PVC EXTERIOR DOOR LOUVER with FG SCREEN	6

ALUMINUM VENTILATING DOOR LOUVERS



SKU	Description	Finish	CASE PK
A1212D1M	12x12 Door Louver	Anodized Aluminum	4 / 10
A1818D1M	18x18 Door Louver	Anodized Aluminum	4 / 10
A2020D1M	20x20 Door Louver	Anodized Aluminum	4 / 10
A2412D1M	24x12 Door Louver	Anodized Aluminum	4 / 10
A2424D1M	24x24 Door Louver	Anodized Aluminum	4 / 10
A2064D1M	20x64 Door Louver	Anodized Aluminum	4 / 10

FULL-LENGTH LOUVERS HAVE ONE VERTICAL AND THREE HORIZONTAL SUPPORTS.

Heavy-duty louvers custom sizes are available.

SDL BAR

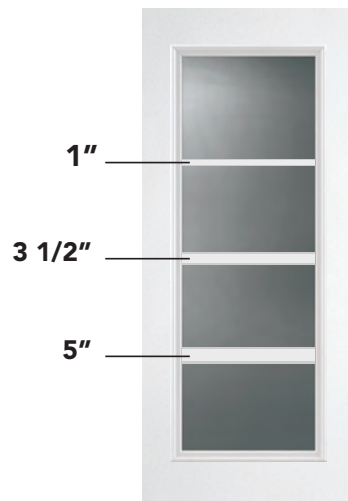

SMOOTH WHITE MI PROFILE FOR USE WITH ODL IMPACT DOORGLASS

SKU	DESCRIPTION	BOX QTY
SDLBAR1WH94	94" Length x 1" Width x 3/16" Projection	63
SDLBAR312WH94	94" Length x 3-1/2" Width x 3/8" Projection	11
SDLBAR5WH94	94" Length x 5" Width x 3/8" Projection	7

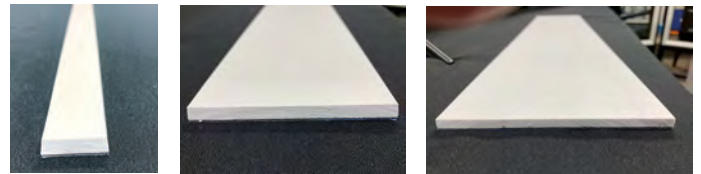

TEXTURED WHITE MI PROFILE FOR USE WITH ODL NON-IMPACT ZEEL DOORGLASS

SKU	DESCRIPTION	BOX QTY
SDLBAR1ZLWH94	94" Length x 1" Width x 3/16" Projection	63
SDLBAR312ZLWH94	94" Length x 3-1/2" Width x 3/16" Projection	11
SDLBAR5ZLWH94	94" Length x 5" Width x 3/16" Projection	7

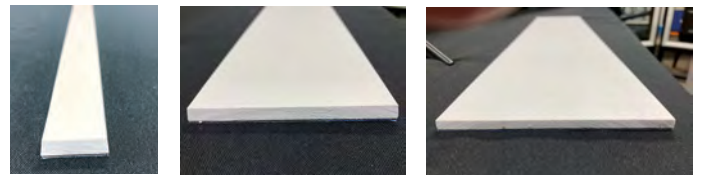

BRUSHED WHITE SR PROFILE FOR USE WITH PLASTPRO NOVA90 DIRECTGLAZED DOORS

SKU	DESCRIPTION	BOX QTY
SDLBAR1NVWH94	94" Length x 1" Width x 1/4" Projection	63
SDLBAR312NVWH94	94" Length x 3-1/2" Width x 1/4" Projection	11
SDLBAR5NVWH94	94" Length x 5" Width x 1/4" Projection	7

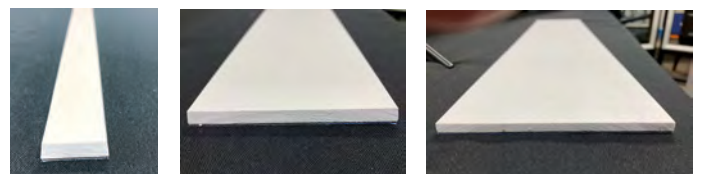

FLUSH BOLTS

FLUSH BOLTS 7"

Designed to fit 1-3/8" wood astragals



SKU	DESCRIPTION	FINISH	CASE PK
FOPFB4003	7" Flip Lever Action Flush Bolt	Bight Brass	10 / 50
34825	7" Flip Lever Action Flush Bolt	Oil Rubbed Bronze	10 / 50
34826	7" Flip Lever Action Flush Bolt	Satin Nickel	10 / 50
FLPFB4005	7" Flip Lever Action Flush Bolt	Antique Brass	10 / 50
FLPFB40026	7" Flip Lever Action Flush Bolt	Bright Chrome	10 / 50
3482710US26D	7" Flip Lever Action Flush Bolt	Dull Chrome	10 / 50
3482715AUS15A	7" Flip Lever Action Flush Bolt	Antique Nickel	10 / 50



FLUSH BOLTS 12"

Designed to fit 1-3/4" wood astragals

SKU	DESCRIPTION	FINISH	CASE PK
458B10B12	12" Flip Lever Action Extension Flush Bolt	Oil Rubbed Bronze	10 / 50
458B1512	12" Flip Lever Action Extension Flush Bolt	Satin Nickel	10 / 50
458B2612	12" Flip Lever Action Extension Flush Bolt	Bright Chrome	10 / 50
458B26D12	12" Flip Lever Action Extension Flush Bolt	Dull Chrome	10 / 50



FLUSH BOLTS 18"

Designed to fit 1-3/8" wood astragals

SKU	DESCRIPTION	FINISH	CASE PK
34829	18" Flip Lever Action Extension Flush Bolt	Oil Rubbed Bronze	10 / 50
34830	18" Flip Lever Action Extension Flush Bolt	Satin Nickel	10 / 50
EXTFB126	18" Flip Lever Action Extension Flush Bolt	Bright Chrome	10 / 50
EXTFB115A	18" Flip Lever Action Extension Flush Bolt	Antique Nickel	10 / 50

BALL CATCHES & DOOR KNOCKER/VIEWERS

BALL CATCHES

SKU	DESCRIPTION	FINISH	CASE PK
31243	2-1/4" Strike Radius Corner Ball Catch	Satin Nickel	25 / 100
31244	2-1/4" Strike Radius Corner Ball Catch	Oil Rubbed Bronze	25 / 100



DRIVE-IN BALL CATCHES

SKU	DESCRIPTION	FINISH	CASE PK
DIB13	2-1/4" Strike Radius Corner Drive-In Ball Catch	Bright Brass	25 / 100
DIB115	2-1/4" Strike Radius Corner Drive-In Ball Catch	Satin Nickel	25 / 100
DIB110B	2-1/4" Strike Radius Corner Drive-In Ball Catch	Oil Rubbed Bronze	25 / 100
DIB15	2-1/4" Strike Radius Corner Drive-In Ball Catch	Antique Brass	25 / 100
DIB115A	2-1/4" Strike Radius Corner Drive-In Ball Catch	Antique Nickel	25 / 100
DIB126D	2-1/4" Strike Radius Corner Drive-In Ball Catch	Satin Chrome	25 / 100
DIB126	2-1/4" Strike Radius Corner Drive-In Ball Catch	Bright Chrome	25 / 100



STRIKES

SKU	DESCRIPTION	FINISH	CASE PK
STRKBC9715	1-3/4"x2-1/4" Strike Only for Radius Corner Ball Catch	Satin Nickel	50 / 500



DOOR KNOCKER/VIEWERS

SKU	DESCRIPTION	FINISH	CASE PK
32439	5-1/2"x9/16" Bore 180 Degree Zinc Cast Door Knocker/ Viewer	Oil Rubbed Bronze	25 / 100
32438	5-1/2"x9/16" Bore 180 Degree Zinc Cast Door Knocker/ Viewer	Satin Nickel	25 / 100
32424	4"x1/2" Bore 160 Degree Zinc Cast Door Knocker/ Viewer	Satin Nickel	25 / 100
32425	4"x1/2" Bore 160 Degree Zinc Cast Door Knocker/ Viewer	Oil Rubbed Bronze	25 / 100



DOOR VIEWERS & SHIPPING PRODUCTS

DOOR VIEWERS



SKU	DESCRIPTION	FINISH	CASE PK
31830	9-16" Bore 180 Degree Solid Brass Viewer	Bright Brass	25 / 100
31832	9-16" Bore 180 Degree Solid Brass Viewer	Bright Chrome	25 / 100
DV18010B	9-16" Bore 180 Degree Solid Brass Viewer	Oil Rubbed Bronze	25 / 100
31840	9-16" Bore 180 Degree Solid Brass Viewer	Satin Nickel	25 / 100
31834	1/2" Bore 180 Degree Solid Brass Viewer	Bright Brass	25 / 100
DV915	1/2" Bore 180 Degree Solid Brass Viewer	Antique Brass	25 / 100
31836	1/2" Bore 180 Degree Solid Brass Viewer	Bright Chrome	25 / 100
31842	1/2" Bore 180 Degree Solid Brass Viewer	Satin Nickel	25 / 100
31843	1/2" Bore 180 Degree Solid Brass Viewer	Oil Rubbed Bronze	25 / 100
31857	1/2" Bore 180 Degree Solid Brass Viewer U/L Listed	Satin Nickel	25 / 100

SHIPPING PRODUCTS

SKU	DESCRIPTION	CASE PK
HB2000	Rubber Hinge Protection Sleeve	1000
CRRLT3002IP	Pre-Hung Shipping Closure Bolt	1000
DSFSP	Door Slab Foam Shipping Protector	360

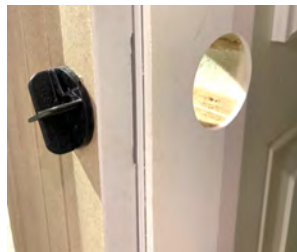



8/0
31-1/16"
6/8
21"



DOOR SHOP COMPONENTS

you can *Trust.*

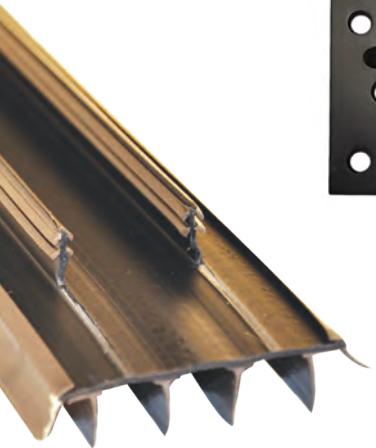

Stile

34" 37"
Typ. to
Bottom
of Door

VOLUME 2